



Wireless Streaming Video  
IP Network Camera

NC-219W



Enter →  
Setting →



Wireless Streaming Video  
IP Network Camera

NC-220WF



Enter →  
Setting →



Wireless Streaming Video  
IP Network Camera

NC-336W HD 1080P



Enter →  
Setting →

**View Your World Anywhere.....Anytime !**

**Camera Installation on PC and Mac**

**This manual applies to all Trivision products. Please read this manual carefully before attempting to install or operate this product.**

**Note: Proceed to the Quick Guide for IOS, Android, PC, Mac**

<b>1.0 Introduction</b>	<b>4</b>
<b>2.0 Installation</b>	<b>5</b>
2.1 Pre-requisites and Initial Connection	5
2.2 PC Quick start	6
2.2.1 Camera Setup Software Installation for PC	7
2.2.2 Finding your Camera with Camera Setup Utility	8
2.3 Mac Quick start	9
2.3.1 Apple Airport Remote Access Setup	11
2.4 Camera Homepage	12
2.5 Live View (using Internet Explorer)	13
2.6 Live View (using Firefox, Safari and other browsers)	15
<b>3.0 Wi-Fi Wireless Setup for PC and Mac</b>	<b>16</b>
3.1 Wi-Fi Troubleshooting	19
<b>4.0 Remote Access Setup</b>	<b>20</b>
4.1 Is the Remote Access Setup already done?	20
4.2 UPNP Setup--Enabling UPnP for Automatic Remote Access Setup	21
4.3 Overview of Manual IP address setup (Without UPNP)	22
4.3.1 TCP/IP SETUP--Manual Setup Step 1	23
4.3.2 Manual Setup step 2	25
4.4 DDNS SETUP	26
4.4.1 DDNS SETUP Step 1	26
4.4.2 DDNS SETUP Step 2	27
<b>5.0 Positioning and Mounting</b>	<b>29</b>
<b>6.0 CAMERASETTINGS</b>	<b>31</b>
6.1 Login Password Modification	31
6.2 Quick Setup with the Wizard	32
6.3 System Page	33
6.4 Reboot	33
<b>6.5 Camera Menu</b>	<b>34</b>
6.5.1 Camera Setup	34
6.5.2 Stream Setup	35
6.5.3 Image Setup	37
6.5.4 OSD Setup	38
6.5.5 Night Vision Settings	39
<b>6.6 Network Menu</b>	<b>40</b>
<b>6.7 STORAGE Menu</b>	<b>41</b>
6.7.1 Storage Setup	41
6.7.2 MicroSD Card Information and Installation	42
6.7.3 MicroSD card installation	43
6.7.4 NAS STORAGE SETUP	45
6.7.5 Browse Storage	46
6.7.6 Format SD Card	47
<b>6.8 TASK Menu</b>	<b>48</b>
6.8.1 Motion Detection using Internet Explorer	48
6.8.2 Motion Detection using Firefox, Chrome, Safari	49
6.8.3 Schedule Setup	50
6.8.4 Task Management	51
6.8.4.1 Email Alarm Sending/Email Periodic Sending	52
6.8.4.2 Email Periodic Sending	54
6.8.4.3 FTP Alarm Sending/FTP Periodic Sending	55
6.8.4.4 Snapshot to Storage on Alarm or Periodically	57
6.8.4.5 Record to Storage on Alarm or Continuously	58

6.8.4.6 Send files in storage to FTP server-----	59
6.8.4.7 Push Notification-----	60
<b>6.9 Tools Menu-----</b>	<b>61</b>
6.9.1 System Identity-----	61
6.9.2 User Management-----	62
6.9.3 Date & Time-----	63
6.9.4 Backup and Reset-----	64
6.9.5 Automatic Reboot Setup-----	64
6.9.6 Firmware Upgrade-----	65
6.9.7 Resetting the Camera back to Factory Settings-----	67
Appendix A: Wireless setup instructions without Cat5-----	68
Appendix B: Setup instructions for ATT (2Wire) Router-----	68
Appendix C: Manually entering TCP/IP Settings for a Camera -----	69
Appendix D: Enabling Active X in Internet Explorer-----	70
Appendix E: Recovering from a failed Firmware update using Windows-----	71
Appendix F: Connecting your Camera directly to a Computer-----	72
Appendix G: Burglar Alarm system integration with digital I/O-----	73
<b>7.0 TROUBLESHOOTING-----</b>	<b>74</b>
<b>CONTACT US -----</b>	<b>75</b>

# 1.0 Introduction

## **Thank you for purchasing a TriVision internet video camera.**

The camera can be accessed remotely, and controlled from any PC/laptop over an Intranet or the Internet via a web browser. The user friendly installation procedure and intuitive web-based interface allows easy integration with your home or business network or Wi-Fi. The camera also comes with motion detection software that can generate alarm triggers via e-mail and by uploading images straight to a website. In our experience, we find that our customers get comfortable with advanced features quickly and then start using the camera on a daily basis to keep in touch with their home or loved ones.

Using a Mac or PC you can view very high quality live streaming video direct from the camera. It is excellent for applications such as a baby monitor, nanny cam, pet cam, party cam, security & surveillance, remote observation, elder and patient care as well as limited video conferencing or event broadcasting.

**An exciting new feature is the ability to turn your iPhone, iPad iOS device and Android OS smartphone, Tablet into a baby monitor without professional installer, Extra wires, IP address setting, DDNS address setting or router setting needed, just plug and play. (For detail, Please check the Quick Guide).**



## **Notice**

This product may cause interference with other wireless equipment that operate at 2.4GHz ISM band. In the event of interference please turn off one of the devices or move it to a safe distance.

## **Product Assurance**

This 2.4GHz wireless camera meets wireless frequency security standards and recommended indexes during operation. These standards and indexes are certificated by the academic organization as illustrated in the following paragraphs. Setup of the camera is mostly automatic if you have a current, industry standard router with the "Plug and Play" apps.

After you are familiar with the basic functionality of the camera you can enjoy many additional advanced features. For instance, you can enable the automatic sending of motion detection email alerts or automatic uploading of pictures to online servers using the FTP protocol. For instance, you can enable the automatic sending of motion detection email alerts or automatic uploading of pictures to online servers using the FTP protocol.

Another exciting new feature is the ability to turn the camera into a DVR (Digital Video Recorder) by recording video or pictures to a Micro SD memory card. You can also turn the camera into a standalone NVR (Network Video Recorder) by enabling functionality to save recorded video files to a network server. This could be a commercial server on the internet or your own standalone NAS (Network attached Storage) hard drive with built-in FTP server. These features do not require a computer. If you wish to use a PC for recording video, we also include free windows software for recording multiple cameras at once.

This requires reliable internet service. If you have an older router that is not up to the task, we highly recommend upgrading to one of the current models before you proceed with the camera setup.

# 2.0 Installation

## 2.1 Pre-requisites and Initial Connection

1. TriVision box indoor models, bullets outdoor cameras
2. Windows PC or Mac OS or Linux computer with internet browser  
Computer is only required for initial setup, later the camera can work by itself without any computer present at the camera location
3. A local area network with a router / gateway and an available Cat5 wired network jack on your router (not on your computer)  
The wired network connection is only needed for initial setup, later the camera can be used wireless with 802.11b/g/n. If no Cat5 jack is available, please see Appendix B for alternative setup procedure.

*You can start using the camera on your own network almost as soon as you plug it in.*

1. *Just connect the included blue Cat5 cable to the network jack on the camera and connection the other end to one of the LAN jacks of your router*
2. *then connect the power supply to the camera and to a wall plug. If your camera has a removable antenna, you may want to attach it now.*

**IMPORTANT: Make sure camera is plugged into your router/ Airport Extreme/ Time Capsule, not the computer, even if your computer has an available Cat5 LAN jack.**

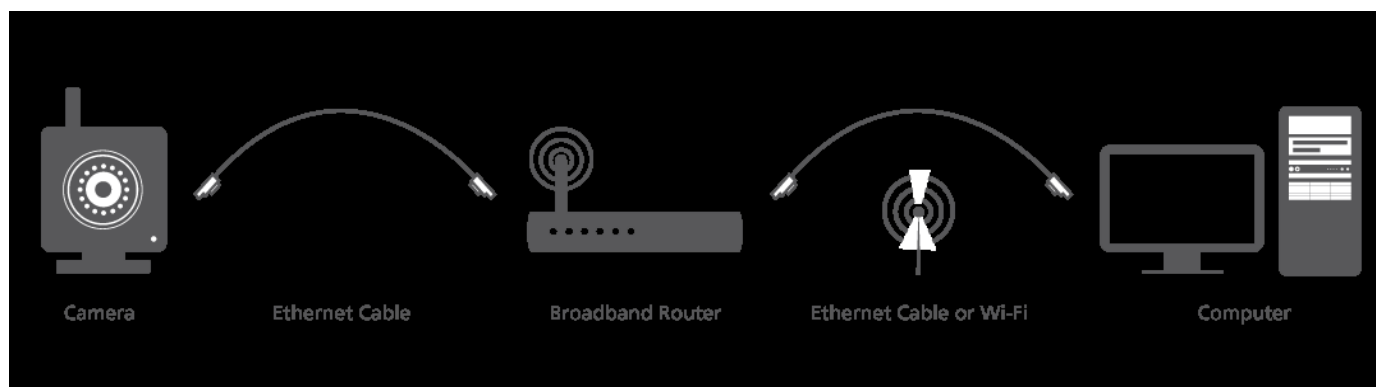

On the box indoor ranges you may want to remove the clear plastic film that is protecting the lens cover. For clearest video be careful not to touch the lens.

On indoor models the power light will come on within a few seconds. Later you should also see it blinking red occasionally. This means your camera is ready to use. To get started, you need to know the IP address that your router assigned to the camera. By adding `http://` in front of the IP address you get a web link to the camera's built-in web server.

Until you setup a name for your camera as shown in later sections of this manual, you typically access the camera by typing the numbers into your browser or by using a bookmark.

## 2.2 PC Quickstart

This Quickstart section applies to the most common configuration for PC users: You have a current generation router such as NetGear, LinkSys, or Dlink connected to a standard, non-routing DSL or cable modem, or you have a combination modem and router which has all functions in one box.

Some of our customers have more complicated networks because they have added a wireless router to a wired router, or have business firewalls or VoIP routers in front of the main router. In those situations we recommend that you consult an expert to simplify your network by eliminating redundant routers or placing all but one router into bridge mode.

With your camera powered up and connected to the router, some PCs will automatically discover the camera and show a pop up window or icon to let you know that a new device has been found. The popup window shows the complete local IP address for the camera. Or, it could be that your camera is automatically discovered by your computer and is shown in the list of attached network devices. On Windows XP this list is called **“My network places”**. On Vista and Windows 7 it is just called **“Network”**

However, some PCs and routers do not have the **“UPnP”** Universal Plug-and-Play feature enabled. In following we will show alternate ways to find the address that your router has assigned to the camera.

If you are familiar with your router’s menus you can log in to your router and see the IP address for the IP network camera in one of your router’s LAN status screens. By the way, in this document we’re using the words **“router”** and **“gateway”** interchangeably.

## 2.2.1 Camera Setup Software Installation for PC

For PC users, we supply a program on the CD called **Camera Setup for PC with Windows7, Windows 8, XP or Vista**. This will install utility called Camera Setup software on your computer. The Camera Setup software searches your local network and displays any cameras it finds. It's very useful if you ever forget the address of you camera or in this case. If this is the first time you are running the program you may need to click **“Refresh”** several times.

Insert provided Software CD into computer’s CD-ROM drive. If the software installation program does not start automatically, open CD-ROM Drive and double click on “Auto Run”.

Install “Camera Setup” applications on your computer using “Install Software” option.

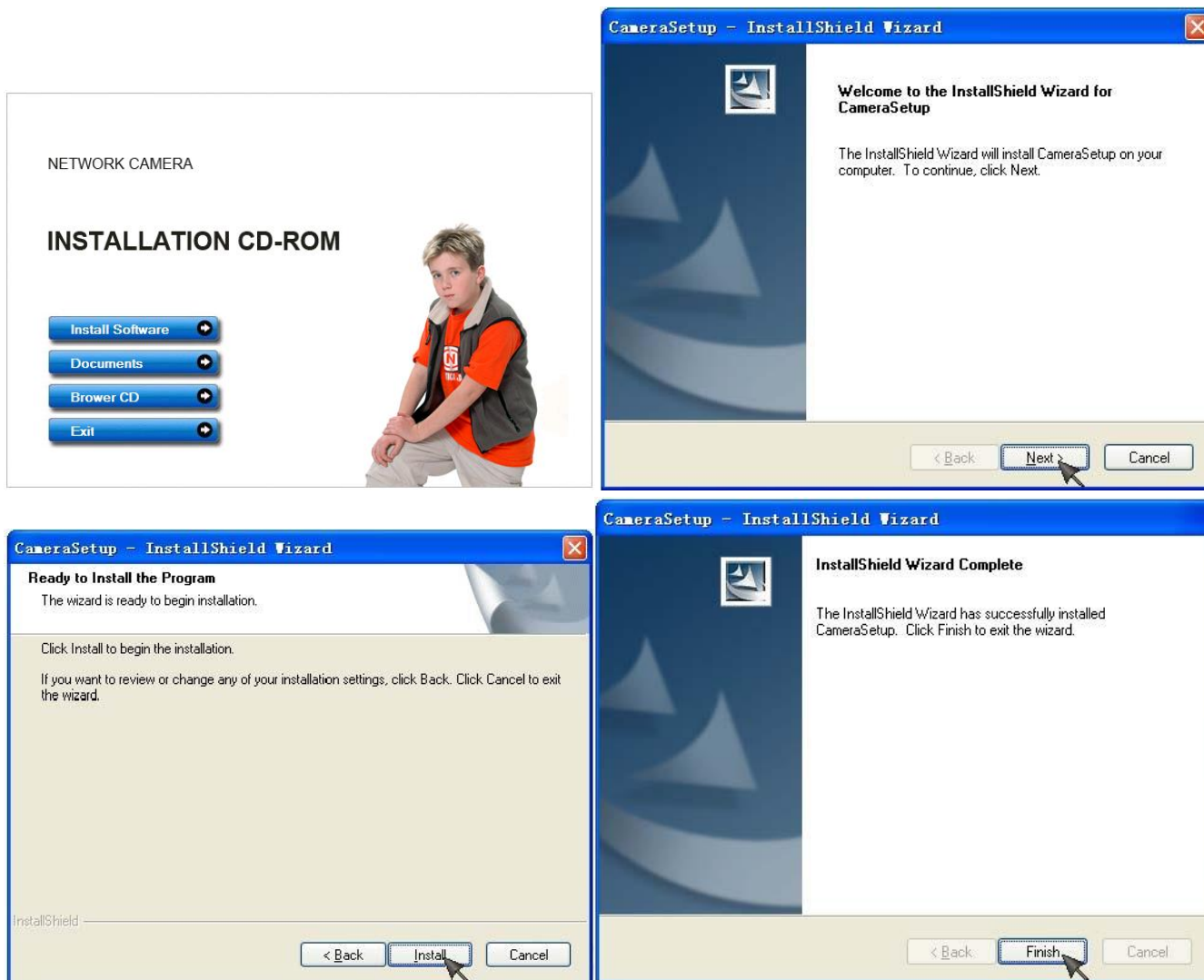

Click Finish to end the installation. You should now find a **Camera setup** icon on your Desktop

## 2.2.2 Finding your Camera with Camera Setup Utility

Now you have your camera attached and the software ready, you are ready to find your camera on your network. Double-click the **Camera setup** icon on your Desktop to launch the Camera Setup program.

The Camera Setup utility should automatically find your camera if it is correctly connected (See image below). You can use this program to set up cameras but we recommend that you use this program only to find your IP address. Then do all setup by going directly to the camera using the IP address, either by double-clicking on the address or by typing the number into your browser (with http:// in front)

If no camera is found it could be that your Antivirus or Firewall program is blocking the “**Camera Setup**” program. In that case you should either disable your Firewall program or use the alternate method of finding the IP address by checking the menus in your router as described below.

Sometimes the program may take a few minutes to find your camera, so if your camera isn’t displayed, wait a few moments and then click “Refresh” to search for cameras again.

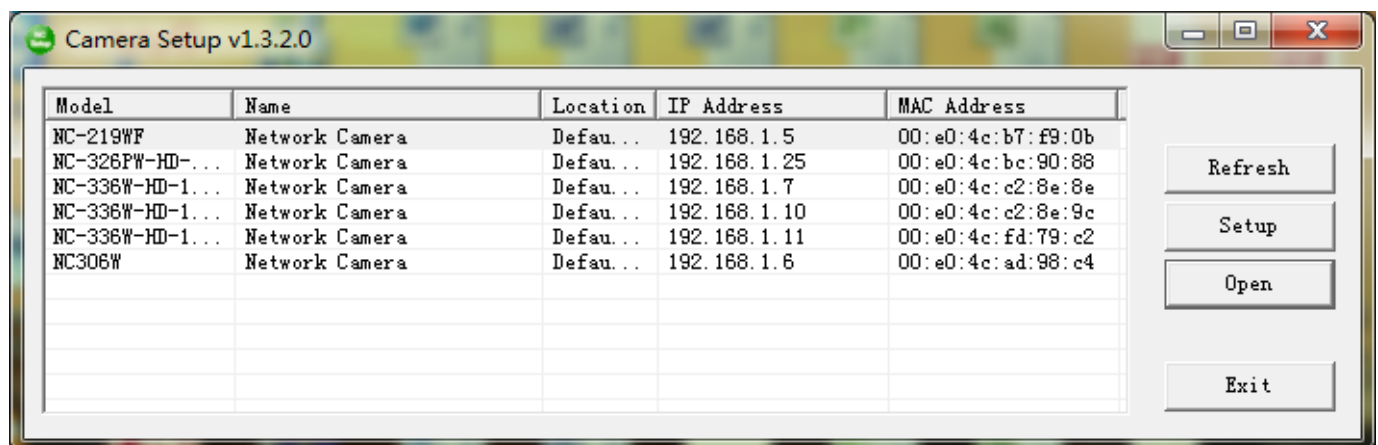

**[Refresh]** – Searches your local network for cameras.

**[Setup]** - Select the required camera and click Setup to configure the network settings for the camera.

**[Open]** - Select the required camera and click Open to access the camera via a web browser.

**[Exit]** - Click Exit to close the Camera Setup window.

Anytime you lose the IP address of your camera, you can run the Setup software to easily find it again.

Once your camera is displayed, either chose “Open” to open the camera.

**Please note: The camera setup will only detect cameras that are on the same network as your computer. Ensure the camera is plugged into the same router/network switch that your computer is connected to**



## 2.3 Mac Quickstart

This Quickstart section applies to the most common configuration for Mac users: You have an Apple Airport (Extreme or Time Capsule), and your Airport is directly connected to a standard, non-routing DSL or cable modem.

In this section you will be interacting mostly with the Airport Utility. Please note that the Airport Utility by clicking on its icon in your Mac's Utilities folder, then make sure it is up to date by going to the menu at the top left of the screen and select "Check for updates". Allow any updates to be installed, and then the "About Airport Utility" menu should show at least version 6.3.1 which is current as of July 2013.

Now select your Airport by highlighting its picture on the left. Click on "Manual Setup" and enter the Airport password if needed, and you should now see the Airport Utility summary screen. Let's verify a few things:

1. The version of your Airport firmware should be 7.5.2 or later if you have a current generation Airport. Unfortunately Apple does not provide firmware updates for the earliest Airports. They can be used with TriVision cameras but require more detailed setup.
2. The "Network Mode" should be "Create a Wireless Network", click on the "wireless" icon on top.

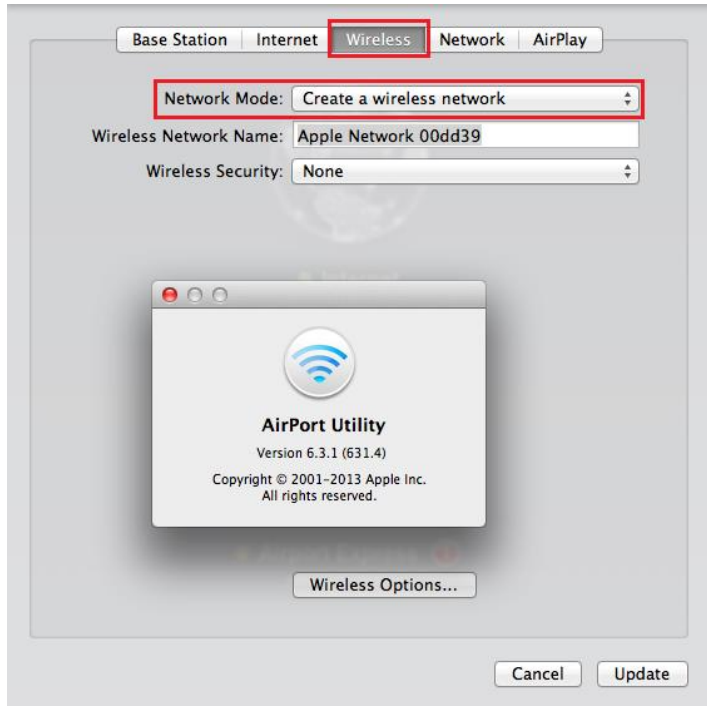

3. Then select the "Network" tab on top and the Router mode is set to "DHCP and NAT". If you have "Bridge Mode (off)" it means you have another router on your network that you may need to eliminate or place into bridge mode before you can have your Airport in "Share a Public IP address" mode. If you have a new generation Airport you will see a "DHCP reservations" box.

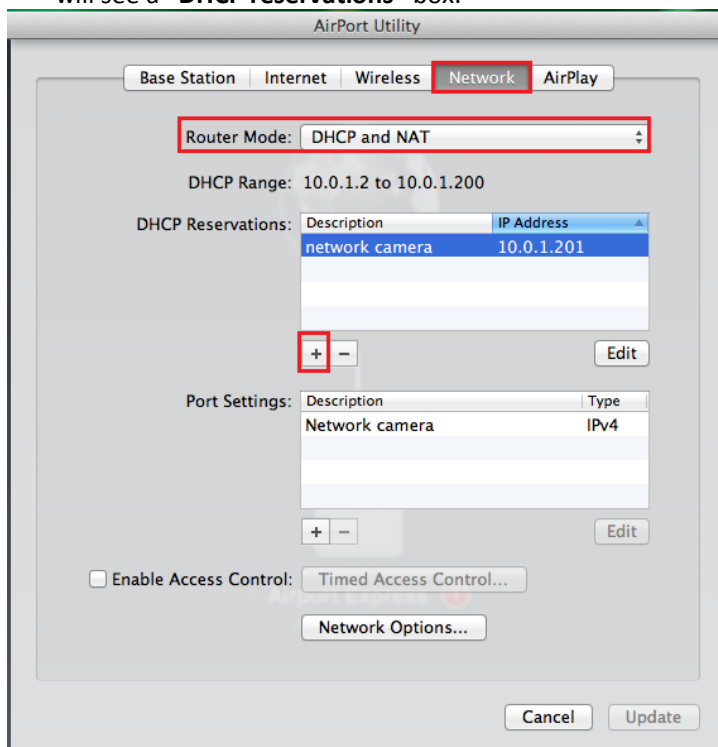

- Click on the + (add) button below this box and enter a description for your camera such as “Network camera”, and select “Reserve address by Mac Address”. Enter the MAC address shown on the back of your camera. Be careful about typos. There are numbers from 0-9 and letters in the range of A-F only. There is no letter O, just number 0 and letter D . Then select a ip address which is in the Airport DHCP range. Make sure that the last group of digits for this IP address does not end in 1 or 254 since those addresses are usually reserved. Click “Save”, and you should have the entry in the “DHCP reservations”.

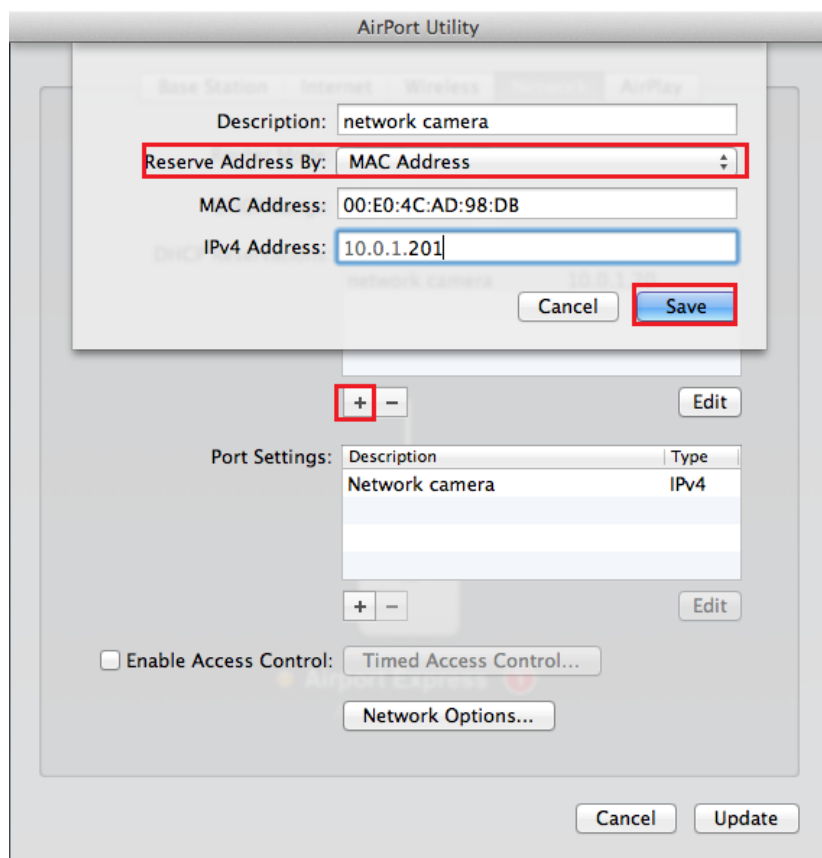

Click “Update” to restart.

Now the IP camera should always be on your network at the IP address that you reserved, regardless of whether you’re using the camera with a wired network connection or wireless after completing the wireless setup.

With older generation Airports the IP address reservation feature is missing in the Airport Utility, however the IP camera can be set up for a fixed local IP address using its own TCP/IP setup menu.

Next you will probably want to set up the wireless connection. To prepare your Airport for easiest and most reliable connection to an IP camera, check the following settings using the Airport Utility.

- If you have set up your network with extra tight security using the “MAC address Access Control” feature in the Airport Utility, then you will need to add the camera’s MAC address to the allowed list.
- If you have set up your wireless network as “Closed” with a hidden name, it is highly recommended to temporarily set your network into a normal configuration with a visible network name. Otherwise your camera will not be able to see your network as one of the available choices to connect to. After setup you can hide your network name again. In general, a hidden network name adds more confusion than actual security. There are tools that can reveal hidden names easily.

## 2.3.1 Apple Airport Remote Access Setup

In order to access the camera remotely from outside your network, you have to tell your Airport to allow access to the network ports used by the camera. This is called “**port setting**” and is done with Airport utility as follows:

In the Airport Utility version 6.3.1, go to manual setup and select the “**Network**” icon.

1. Click on the **+** (**add**) button below the “**port setting**”.

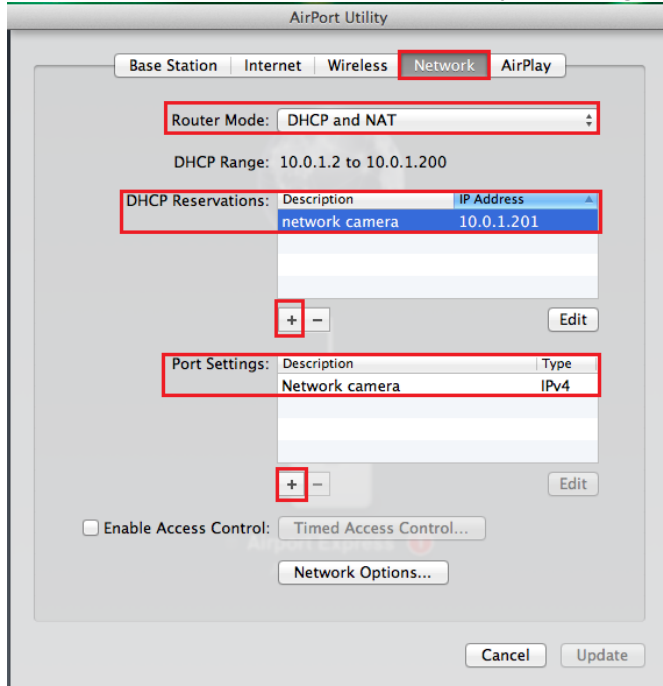

2. then click on the **+(add)** icon at the bottom of the box, and enter the following info:

**Public UDP port:** 30000-30001 (next camera would have 30002-30003 etc)

**Public TCP port:** 8150 (your 2<sup>nd</sup> camera would have 8151 here, 3<sup>rd</sup> 8152 etc)

**Private IP address:** (add the IP address for your camera, e.g. 10.0.1.201)

**Private UDP port:** 30000-30001 (same as public UDP port)

**Private TCP port:** 80

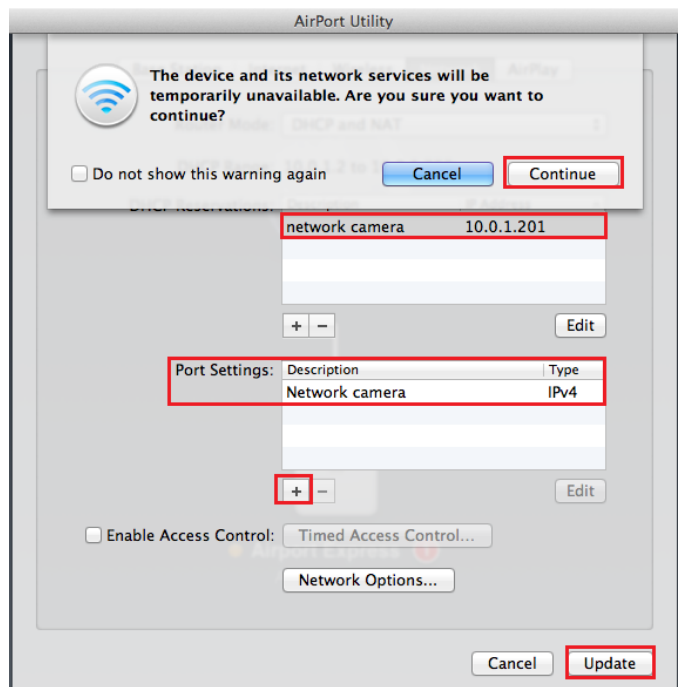
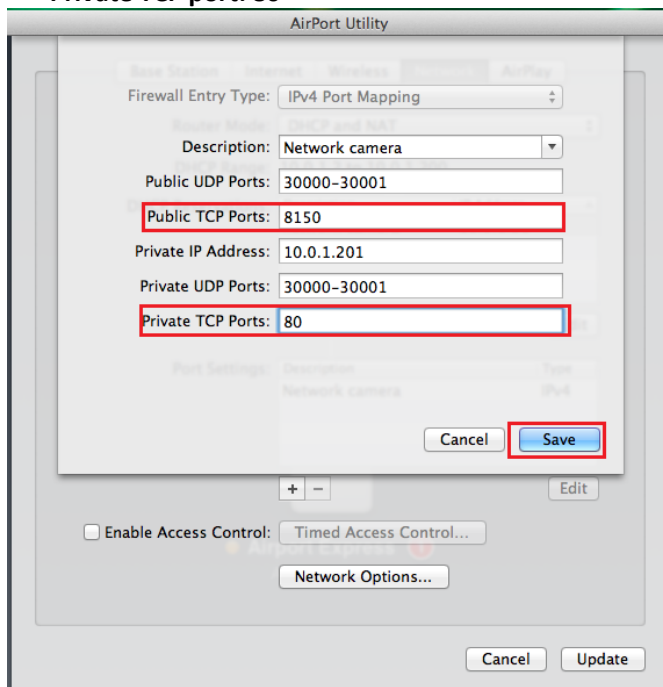

3. Then click on “**save**”, “**Update**” and “**Continue**” to restart your airport.

Now some from the outside your network should be able to access your camera using your external IP address with: **8150** added to the end. For example, if the Airport summary screen shows your IP address as 183.37.136.55, you would enter the following in your browser: <http://183.37.136.55:8150>.

This assumes your Airport is your only router. You can check this by going to [www.checkip.org](http://www.checkip.org). The IP address shown there should be the same as shown in your Airport.

## 2.4 Camera Homepage

Regardless of the method you used to find your camera's IP address, Once you have used the Camera Setup Software to find your camera and opened your selected camera or entered the IP address manually into your browser" (with http:// in front) , you will be greeted with the TriVision Homepage for your camera (which should look something like the below screenshot depending on your model):

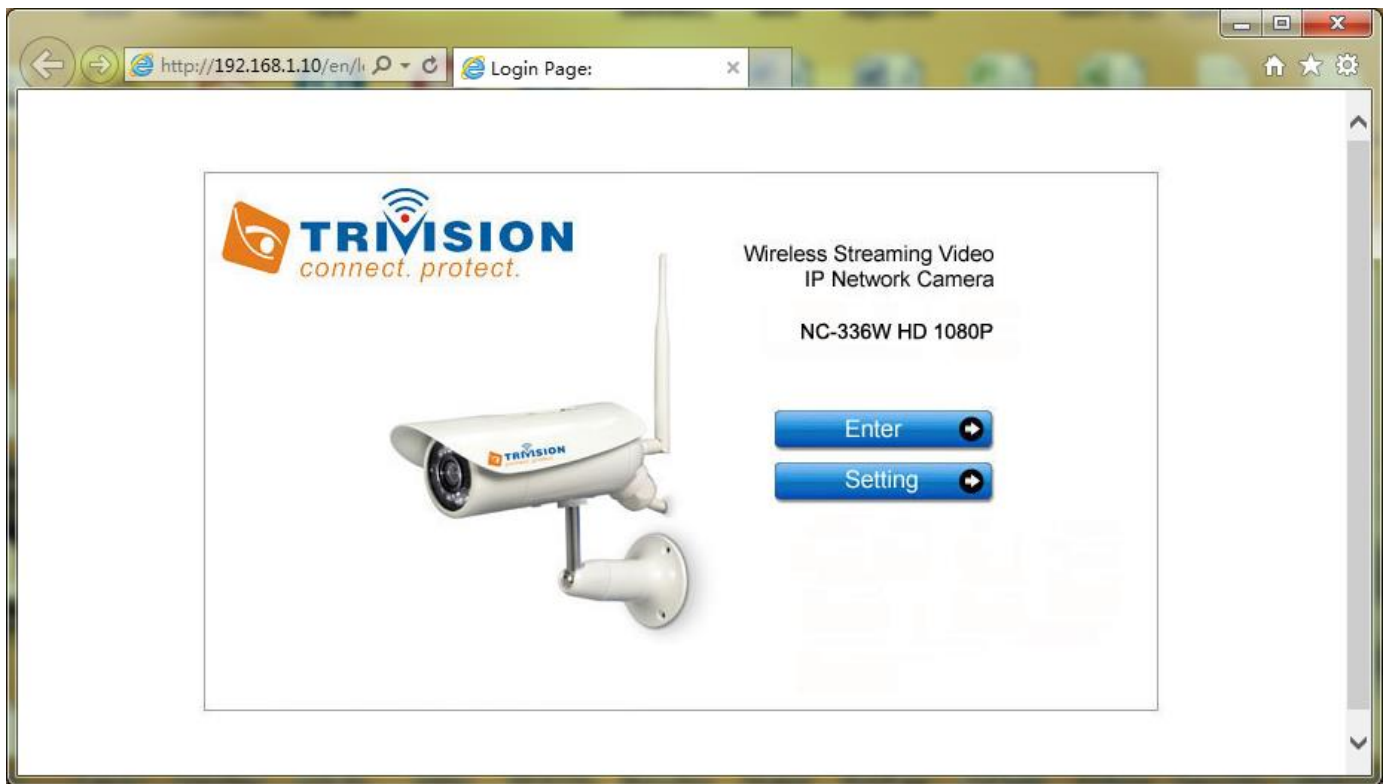

**[Enter]** Lets you view live video transmitted by the camera.

**[Setting]** This section allows you to setup your camera with its various settings.

To see video, click on **"Enter"**,

The default setting:

**Username: admin**

**Password: admin.**

This is login is case sensitive, so should be entered exactly as they are above. It is recommended you change your password as soon as you are logged in - to avoid unauthorized access to the camera. Make a note of the password somewhere safe, as the only way to reset the password is to reset the cameras, so all settings will be lost.

***Please note: The password can be any mixture of lower and uppercase alpha-numeric characters. Extended characters are not permitted***

## 2.5 Live View (using Internet Explorer)

When using the camera for the first time on a PC with Internet Explorer, your PC will ask you for permission to install the viewing software (**called ActiveX**). This ActiveX is needed to decode the H.264 or MPEG4 video stream and control the camera. Click to “OK” this at the top of your screen, then again click on “OK” on the install menu that will pop up in the middle of your screen.

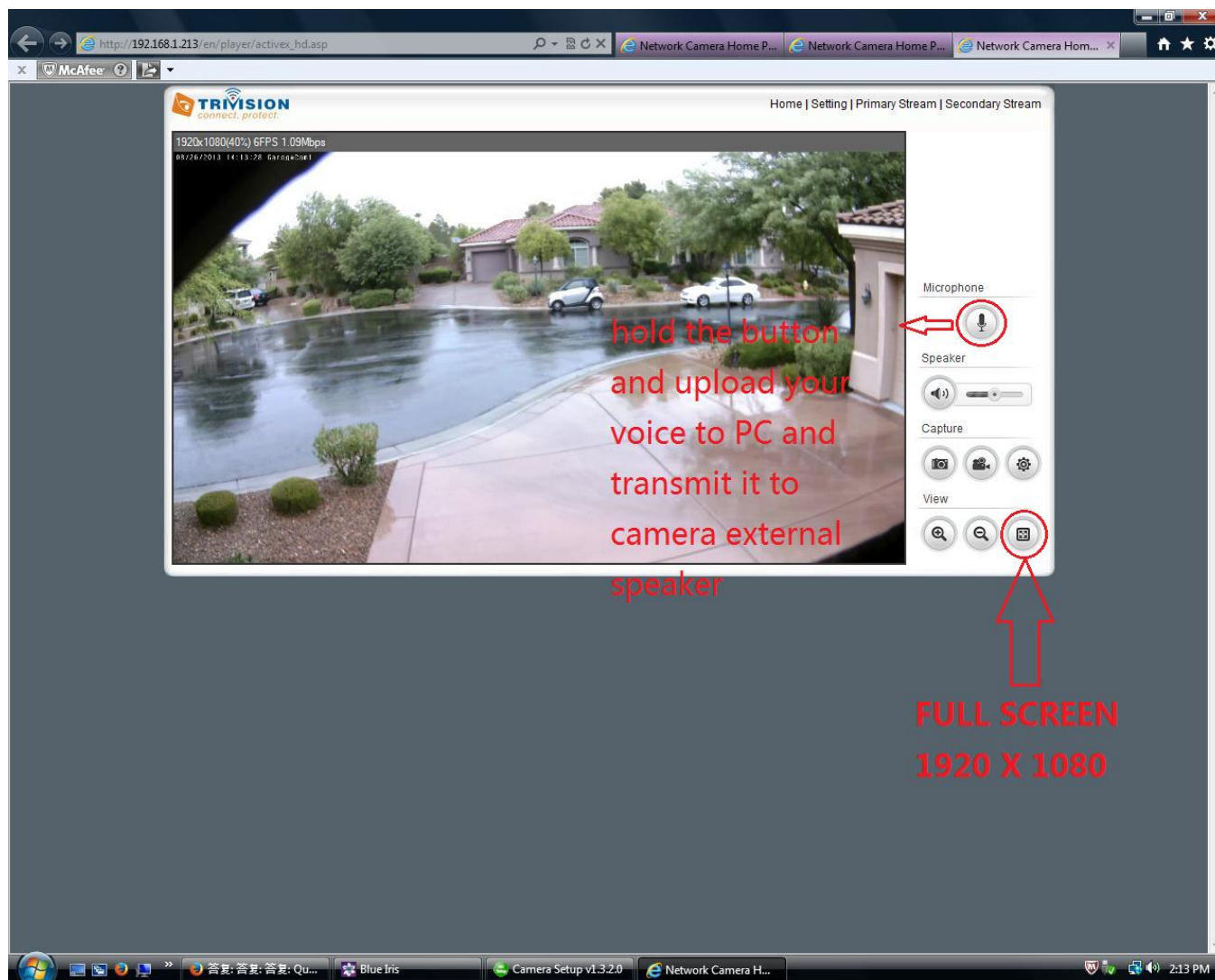

If you have a popup blocker like Google Toolbar you will need to disable it. Within a few seconds you can then see live video from the camera.



**NOTE:** If the camera shows video but also displays the message “connecting, waiting...”, close Internet Explorer and wait a couple of minutes for the camera to obtain current time from a internet time server and restart itself.

The two links at the top of the screen are Home and Settings.

**[Home]** This takes you back to your Camera Homepage.

**[Settings]** This will take you to the cameras internal settings.

Please view the next page for an explanation of the Operating Bar settings.

<p>Speaker</p>  <p>1 2</p>	<p><b>1) Mute:</b> Click the Mute button to silence the audio stream from the camera.</p> <p><b>2) Volume:</b> Slide the slide block horizontally to adjust volume.</p>
<p>Capture</p>  <p>1 2 3</p>	<p><b>1) Snapshot:</b> Press the Snapshot button to capture a still image of the camera view, these will automatically be saved to the My Documents/ Pictures folder.</p> <p><b>2) Video Clip:</b> Press the video record button to enable video recording to your local computer. Once finished press the button again to stop recording. The video clip will be saved by default to the Videos directory.</p> <p><b>3) Settings:</b> The Settings button allows you to set the location where the snapshot and the video clips will be saved.</p>
<p>View</p>  <p>1 2 3</p>	<p><b>1) Zoom:</b> Click on the “+” button and the cursor turns to a magnifier. Move the magnifier to the desired location and click on an image area.</p> <p><b>2) Zoom Out:</b> Press the “-” button to return to the normal view.</p> <p><b>3) Full screen:</b> Press the button to enable full screen (this functionality is available on HD 720P and HD 1080P models)</p>



## 2.6 Live View (using Firefox, Safari)

Upon verification of the username and password, the camera image will begin to load.

Adobe Flash Player or QuickTime or your media program may ask you to re-enter your login username and password at this point. This is common on most systems.



**Please note: You need to have QuickTime Pro Installed on your system to record videos directly from the web browser if you are using a program other than Internet Explorer.**

The links at the top of the screen are **Home, Settings, Secondary Stream and Motion JPEG**.

**[Home]** This takes you back to your Camera Homepage.

**[Settings]** will take you to the cameras internal settings.

**[Secondary Stream]** This is set via your settings, and is useful if you need a lower resolution stream for certain devices (e.g. some mobiles and software)

**[Motion JPEG]** This is a continuous motion JPEG stream – without any audio.

## 3.0 Wi-Fi Wireless Setup for PC and Mac

Most likely your wireless network was set up with a password (also known as wireless key). If you don't remember it, you can check your router's wireless setup menu or ask the person who set up your wireless network.

Without your password you **cannot** proceed with your camera's wireless setup, so you can either continue to use your camera in wired mode or set up a new password in your router. Another possibility is to disable passwords in your router but an unsecured wireless network is not recommended.

After installing the camera setup utility on PC and assigned the fixed ip address for your ip camera on Mac, now you can start using your camera immediately using the IP address. Just add http:// in front of it and open it in a browser, such as <http://192.168.1.10>

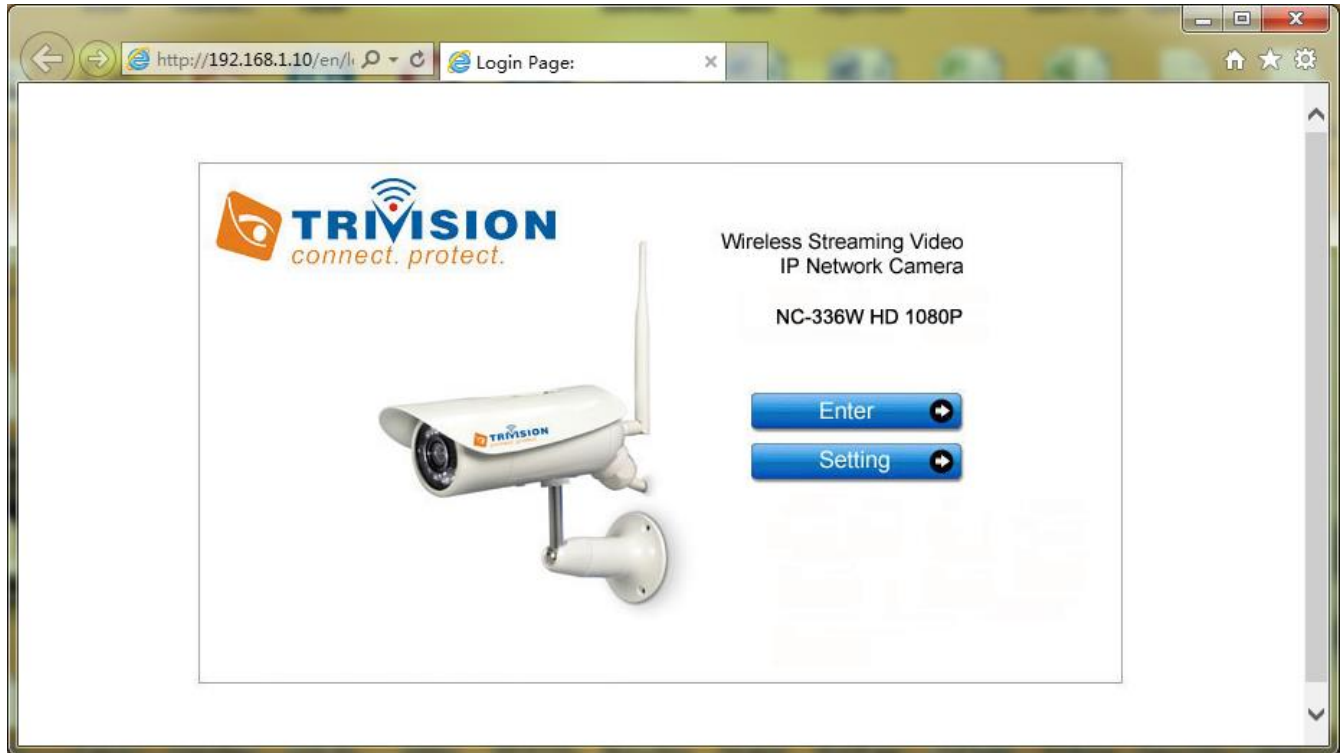

Clicking on “**setting**” from the main camera login screen will get you to this:

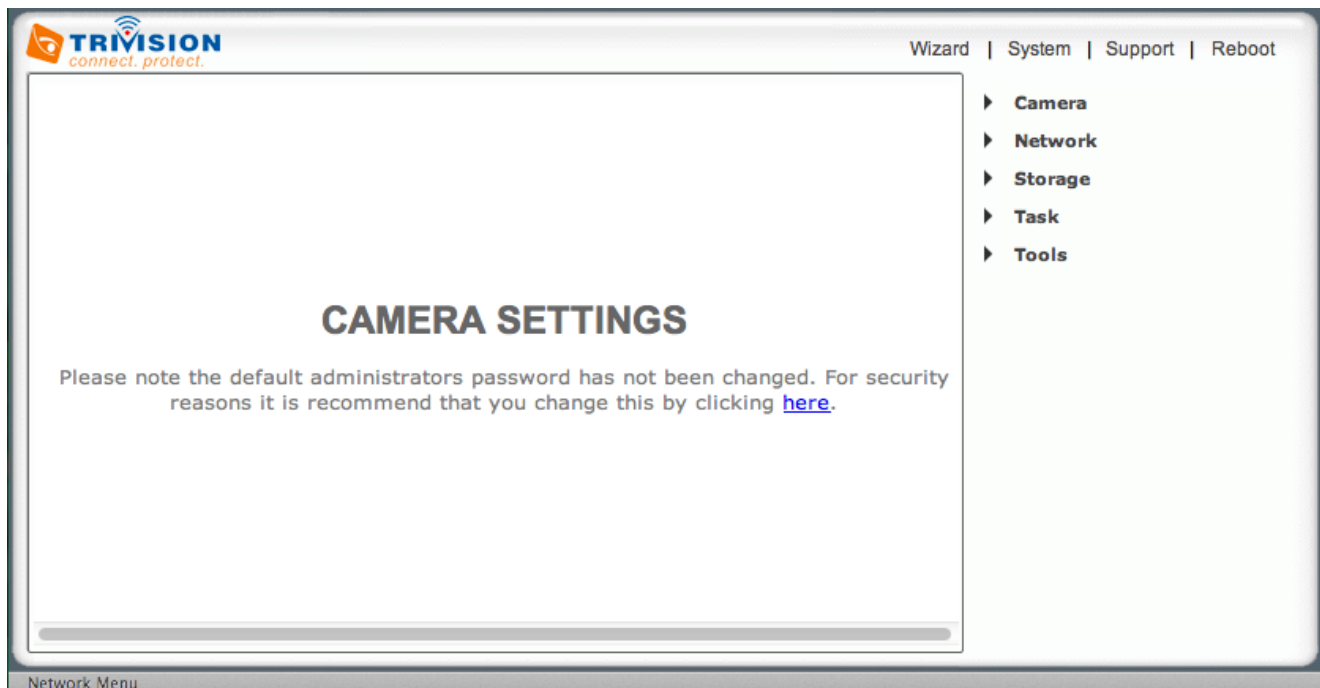



Click on **“Network”**, then click on **“Wireless setup”**, and you’ll get to this screen :

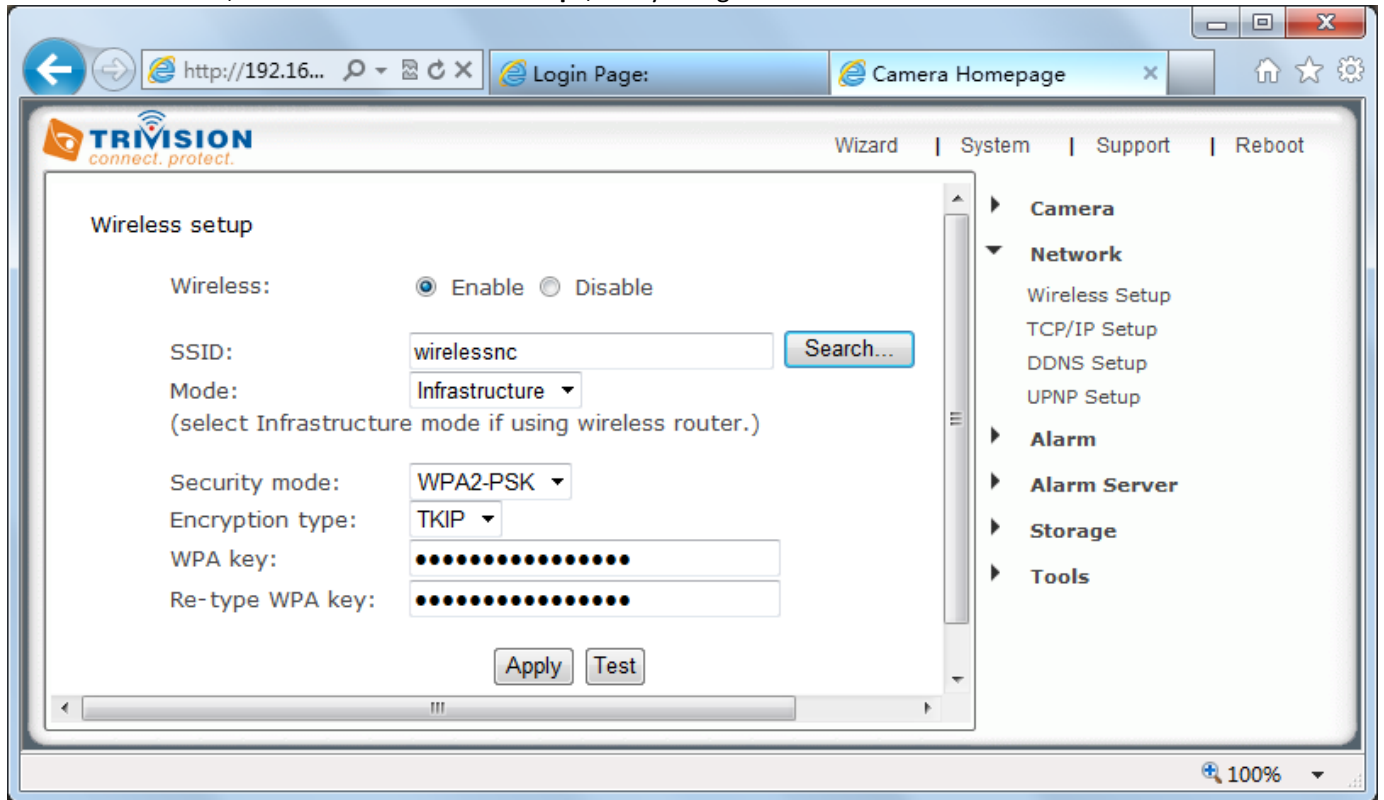

Click the **Search** button for the camera to scan for available Wi-Fi networks to connect to. You may see a whole list of networks in your neighborhood. A new screen will display all the wireless networks found.

SSID list

	SSID	Mode	Channel	Auth	Encrypt	Signal
<input checked="" type="radio"/>	NUUO	Infrastructure	9	WPA1PSKWPA2PSK	TKIPAES	📶
<input type="radio"/>	dlink-hzm	Infrastructure	13	SHARED	WEP	📶
<input type="radio"/>	HomeLY	Infrastructure	1	WPA1PSKWPA2PSK	AES	📶
<input type="radio"/>	cy	Infrastructure	1	WPA1PSKWPA2PSK	AES	📶
<input type="radio"/>	hdx-home	Infrastructure	1	WPA2PSK	AES	📶
<input type="radio"/>	TP-LINK_PocketAP_942FC8	Infrastructure	1	OPEN	NONE	📶
<input type="radio"/>	TP-LINK_hzm	Infrastructure	1	WPA1PSKWPA2PSK	AES	📶
<input type="radio"/>	TR950_df53	Infrastructure	4	WPAPSK	AES	📶
<input type="radio"/>	MERCURY_dbq	Infrastructure	6	OPEN	NONE	📶
<input type="radio"/>	admin	Infrastructure	6	WPA1PSKWPA2PSK	AES	📶

Select the desired network, and click **Apply**. The camera will automatically choose the best options for connecting to the network. You then need to enter your Wi-Fi password.

**If your network is not listed, try “Search” again or repositioning your camera nearer to the wireless device or un-hide your network name if your router is configured as a closed system.**

*Do NOT manually change any of the settings (SSID, Mode, security mode, Encryption type)*

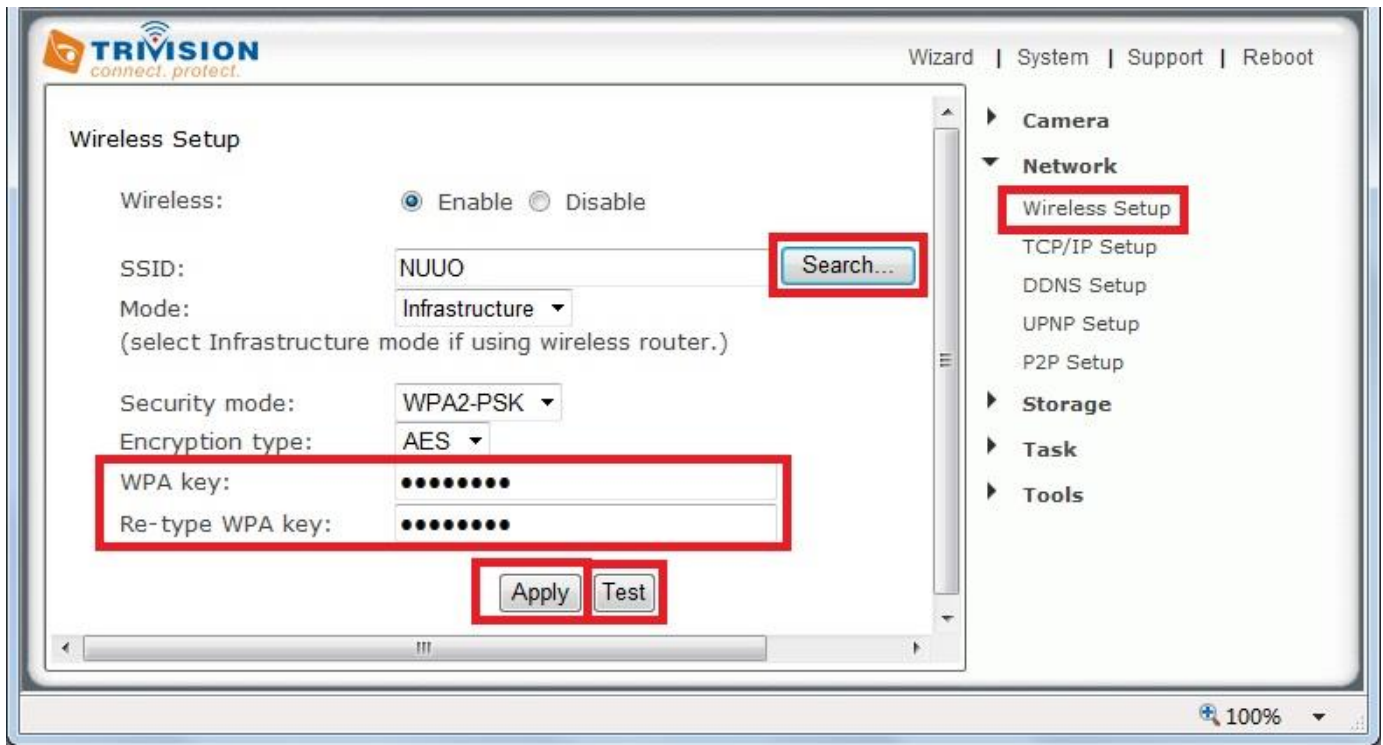

Please remember that both WPA and WPA2 keys are case sensitive and need to be between 8 and 63 characters. When you have entered the key, click on **“Apply”**, you’ll get a message about **“Wireless setup accepted successfully”**, but that only means that the information was stored in the camera. Now you should use the **“Test”** feature to check if you typed it correctly.

If the test reports **“Success!”** you can remove the network cable and it should work wireless after a short delay. If the test reports **“no wireless connection”**, please double check your WPA key (password” and refer both to the Wi-Fi troubleshooting and “Known issues” section of this User Guide.

Congratulations! At this point you should be able to use your camera wired or wireless on your local network using the same local IP address.

If it doesn’t connect, we recommend that you temporarily remove wireless security from your router for a quick experiment to see if the setup succeeds with no passwords. Then put the password back in and try again. Many times this will refresh your memory about the exact spelling of your password. Also, it could be either that the camera is too far from your router, or that your router was set up with the tightest possible security which allows only known devices to connect to your network. In this case, do not forget to add the MAC address of this camera to your allowed list. In this context, MAC refers to a hardware network address and is unrelated to Macintosh computers. The Mac address is printed on the back of the camera.

The maximum distance is dependent on the kinds of walls and objects that are between your wireless router antenna and your camera. One easy test for determining the maximum recommended distance is by using a laptop at the camera location. If your laptop shows at least 80% (4 or 5 bars) signal strength at that exact same location then the camera should be ok too. Any less than that may be unreliable, so you may want to move your router or the camera, or adjust the angle of your router’s antennas.

Keep in mind that the wireless signal travels easily through common building materials such as wood, glass, sheet rock, and vinyl siding, but does not go at all through metal. If there are any big metal objects such as a fridge, filling cabinet, or HVAC ducting in between the Wi-Fi router and the camera, try to reposition either the camera or the router so that the metal object doesn’t block the signal. Also, many microwave ovens and older 2.4GHz cordless phones may interfere with all Wi-Fi networking while in operation. Using a laptop you may not notice a pause, but with a camera that transmits or records video continuously any interruption will be much more obvious. Nearby Bluetooth devices such as cell phone headsets, Playstation game controllers, or a wireless keyboard and mouse can also interfere with wireless networks if the devices are too close.

The best placement for a wireless router is in an area that is higher up and free of nearby clutter, for example on top of a wooden book shelf .

## 3.1 Wi-Fi Troubleshooting

If the camera does not connect and you've already checked the settings mentioned on the previous page, please log in to your router and double check the setting for wireless channel selection. On an Apple airport you would use the Airport Utility.

If the **“Search”** function of the wireless setup page found your Wi-Fi network it means that the wireless networking hardware is working. If it then doesn't connect it means that there is a password or IP address related issue.

***Please note: The password can be any mixture of lower and uppercase alpha-numeric characters. Extended characters are not permitted. Do not use a wireless password with spaces or punctuation in it. For example, “Joe & Mary’s Wi-Fi #2” may not work unless you change it to something like JoeAndMary2”. Also make sure any WPA/WPA2 password is between 8 and 63 characters total.***

You can temporarily turn off passwords on your Wi-Fi router, and if you then set “Security mode” to “off” in the camera, it should connect unless you have set your router to reject connection attempts from unknown devices.

Assuming that you are now at least connecting without passwords, you can proceed to add wireless security to your router and try again. We recommend WPA2 if available, otherwise WPA. The older WEP mode is obsolete and may not work correctly on Apple Airport. If you have trouble, switch to WPA2.

Since each password type can have 2 variations, this means you could have 4 possible combinations: WPA-TKIP, WPA-AES, WPA2-TKIP, and WPA2-AES.

Some routers like Apple Airport series do not show clearly which one of these settings is being used, so if you have difficulty you should try all 4 possible combinations. On a laptop you typically do not need to specify the exact password type since the laptop will try everything automatically. The camera is picky, it needs to know exactly what type of password you are using and does not try anything other than the exact type that you entered.

Remember to **“Apply”** first, then **“Test”**. If it says **“Connected!”** at the end of the test, you can remove the cable. However, as long as the cable is still attached, the camera's **“System”** menu will show **“No wireless connection”**.

If you still have trouble, be sure to check the Appendix for known issues.

# 4.0 Remote Access Setup

## 4.1 Is the Remote Access Setup already done?

If your computer had automatically discovered the camera earlier, this is good news because it means that the “Universal Plug and Play” feature is available on your network and most of the setup may already be done. Your camera would be visible from the internet to anyone who knows the exact IP address and usernames and passwords that you choose.

Keep in mind that there is a distinction between local (intranet) IP addresses, meaning IP addresses on your own network, and external (internet) IP addresses, which are unique in the entire world. With the UPnP feature enabled in your router, the camera’s “System” menu can show you both:

- 1) *The link(URL) for accessing the camera from your own network, often something like <http://192.168.0.100>*
- 2) *The automatically configured link(URL) for access from a remote location, often something like <http://183.37.136.55:8150>*

A quick comment about ports: In general, IP addresses can have many different ports associated with them. When browsing to ordinary web sites there is usually no need to specify a port and that’s why you may have never heard about ports at all. However, when different devices share a single IP address they are distinguished with a port. Basically a port has a similar function for an IP address as an extension on a telephone number.

Ports are specified by including the port number in the web address with a colon and the number after the .com or .net domain name. In the example show above the port number is 8150.

If UPnP was available on your network, the camera has already set up the correct ports for remote access. A quick way to see the complete external IP address (URL) is to go to the **System** menu at the top of the **Setting** screen. Scrolling down to the UPnP section you will see the Internet URL (IP address). Then all you need to do is to type either your internal (Intranet) or external (Internet) IP address in your browser, depending whether you’re accessing the camera locally or over the internet. If UPnP worked, you should skip the manual IP address setup and proceed to selecting a name for your camera.

Note: if the system menu shows you an internet URL (external IP address) that starts with 192.168 or 10.0, your DSL or Cable Modem has a built in router. In this case, contact us with the model number of your modem for assistance.

## 4.2 UPNP SETUP---Enabling UPnP for Automatic Remote Access Setup

Usually it is very simple to enable UPnP. You just need to log in to your router's setup screen and find the UPnP menu. Then you click on enable, save the setting and restart both the router and the camera (in that order). The camera comes from the factory with the UPnP enabled. You can double check by selecting the **UPnP Setup** tab under the camera's **Network** menu:

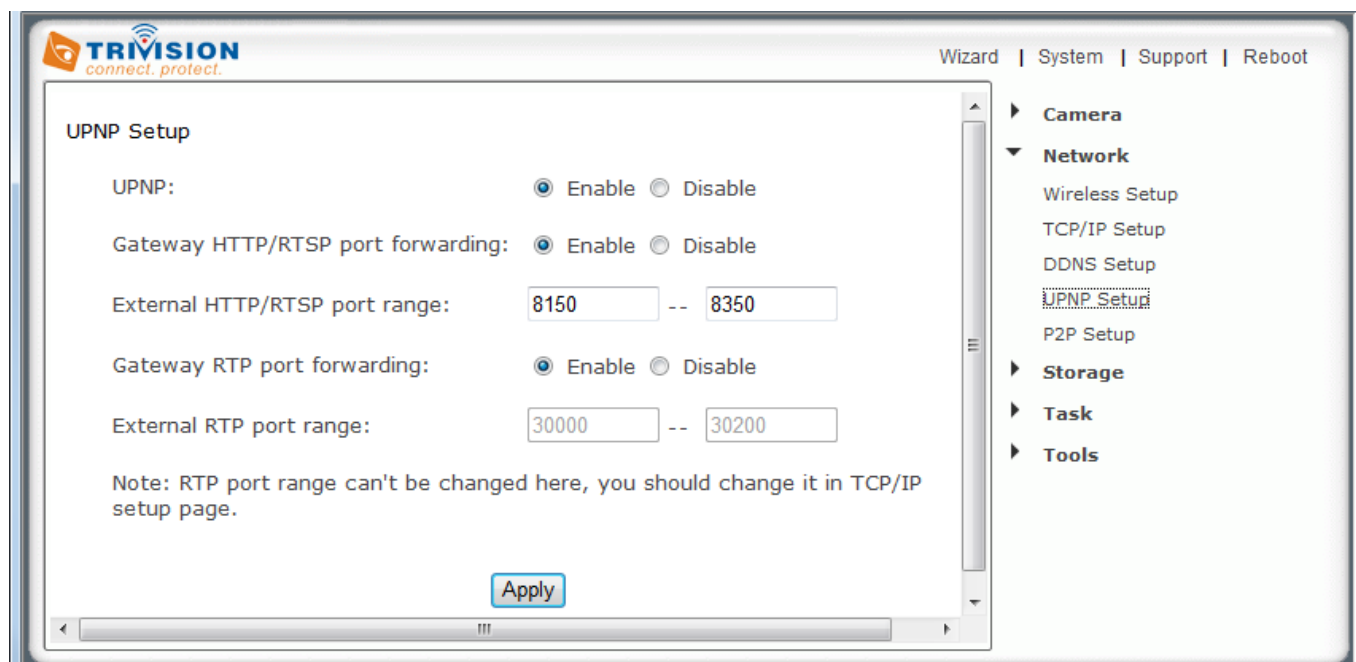

**[UPnP]** Enable or disable the UPnP function. We recommend you to have UPnP enabled. For most users, the rest of the settings can be left as the default settings.

**[Gateway HTTP/RTSP port forwarding]** If this is enabled, the camera will automatically add a port forwarding rule to your router via UPnP protocol. **[External HTTP/RTSP port range]** By default, this port range is 8150 – 8350. The ports are assigned in order, so if you only have one camera attached to your system, the chosen port will be 8150(8150-8150) for the first camera, 8151 for the second(8151---8151), and so on. Every camera will remember its port, and it will automatically use this port (if still available) whenever it is powered on.

**[Gateway RTP port forwarding]** Used when viewing the feed through a VLC player. If not wishing to view the feed through a VLC this should be left enabled.

**[External RTP port range]** The RTP port range can't be changed here - you should change it from the TCP/IP setup page.

Click **Apply** to confirm your setting.

*If your router UPnP is enabled, the UPnP is still not shown as above, then power off the router and restart both the router and camera.*

If UPnP works, clicking on the camera's "system" menu at the top of the setting screen will show something like the following in the UPnP section:

UPNP port forwarding	
Status:	Success
Gateway external IP address:	183.37.126.180
Gateway external port:	8150
Internet URL:	http://183.37.126.180:8150

## 4.3 Overview of Manual IP address setup (without UPnP)

In the previous section we showed how to tell if your camera was able to automatically configure itself using your router's UPnP feature. If UPnP worked, please skip ahead to 4.4.1 DDNS SETUP Step 1---Choosing a Name for your Camera on the Internet

In this section we provide an overview of the manual IP address setup procedure. You would only need to do this if UPnP is not available on your network, for example if you have an older router.

Most routers come pre-configured to protect your own network devices from external access. This means that in order to view your camera remotely over the internet your router needs to be configured to open ports and allow access. If this sounds difficult, you may want to consider upgrading your router to a newer NetGear, LinkSys, or DLink model as they are very inexpensive now (we've seen sales prices under \$40). Either way our tech support can help you.

The terminology for opening up ports can be different based on the manufacturer of the router. Typically this setting is called "Web access", "DMZ", "Virtual Server", "Virtual Service", "User Defined Service", "Port Forwarding" or "Port Mapping". There are 2 main steps involved in port forwarding:

1. Reserving a DHCP address or assigning a permanent (static) IP address for your camera on your local network.
2. Configuring your router to allow access from the internet to the camera's IP address on your local network.

Strictly speaking, step 1 above is optional, but some routers (especially LinkSys and Belkin models) tend to reassign all the IP addresses on your home network after a power failure or based on the order in which you use them. Therefore your setup is only reliable if you reserve a DHCP address or assign a permanent IP address to your camera and then do the actual port forwarding.

Some residential internet service providers want to charge more for business service and therefore deliberately block all internet access that looks like it might involve a web server at the standard port 80. That's why we always recommend using port 8150, which in our experience is never blocked.

## 4.3.1 TCP/IP SETUP --Manual Setup Step 1: Assigning a permanent IP address for your camera on your local network (Without UPnP)

On your home network (LAN) all your computers, printers and other network connected devices have an IP address. In every IP address there are 4 groups of digits that can each vary from 1 to 255. For your home network the first 3 numbers are already determined by your router's address, which is typically something like 192.168.0.1 or 192.168.1.1 or 10.0.1

To pick a permanent address for your camera you first need to know your router's IP address. It is shown in your camera's "system" menu (at the top of the setting screen) if you scroll down to "Default Gateway". The router's IP address determines the first 3 groups of digits for your camera's IP address.

Now we need to select a valid number for the last group of digits. We don't simply pick a random number because we have to avoid numbers that are already taken or could be used by your router. The router uses addresses in a range set aside for this purpose (called the DHCP range). For many routers, this DHCP range is from 2 to 100 but you'll have to check your specific router's DHCP menu. Sometimes this is shown as start and end address, or start address plus number of available addresses.

Why is this important? We want to select an address outside this range to make sure that your router would never pick this address for another device.

For example, if your router uses the DHCP range from 192.168.0.2 to 100, You could choose 192.168.0.101 as a permanent IP address. Conversely, if your router uses DHCP addresses from 100 to 255, you could use 192.168.0.50 to be outside the range. Never use addresses that end in .0 or .1, since that is reserved for your router, and never use addresses that end in a number higher than 255 since that is the highest possible limit.

Now that you have picked a local IP address for your camera, then go to the Camera Settings menu, then select "Network" and "TCP/IP Setup" :

The screenshot displays the Trivision camera's web interface for TCP/IP Setup. The main content area is titled "TCP/IP Setup" and contains the following configuration options:

- Obtain an IP address automatically(DHCP)
- Use the following IP address
  - IP address: 192.168.1.201
  - Subnet mask: 255.255.255.0
  - Default gateway: 192.168.1.1
- Obtain DNS Server address automatically
- Use the following DNS server address
  - Primary DNS IP address: 202.96.134.33
  - Secondary DNS IP address: 202.96.126.86
- HTTP/RTSP port: 80
- RTP port range: 30000 -- 30200

An "Apply" button is located at the bottom center of the form. On the right side, a sidebar menu is visible with the following items: Camera, Network (expanded), Wireless Setup, TCP/IP Setup (highlighted with a red box), DDNS Setup, UPNP Setup, P2P Setup, Storage, Task, and Tools.

The camera is setup to obtain an IP address automatically (DHCP) from your Network by default, so these settings should not be needed by most users.

If your network supports a DHCP server (e.g. router) select this option to have the IP address is assigned automatically.

If you select **Obtain an IP address automatically** you should select **Obtain a DNS Server address automatically**.

**[Obtain an IP address automatically (DHCP)]**

**[Use the following IP address]** Select this option when a fixed IP is required.



**[IP address]** Type the IP address of your camera (Required).

**[Subnet mask]** Type the subnet mask (Required).

**[Default gateway]** Type the default gateway (Required).

**[Primary DNS IP address]** Type the IP address of the primary DNS server, if necessary (Optional).

**[Secondary DNS IP address]** Type the IP address of the secondary DNS server, if necessary (Optional).

**[HTTP port number]** The default HTTP port number is 80.

**[RTSP port range]** In order to view video over RTSP the router should be setup to forward a port in the range 30000 to 30100 to the camera's IP address using UDP with an internal port in the range of 30000 to 30100.

### **If you wish to assign the IP address manually, use this page to enter the address detail.**

1. Click on "use the following IP address". Then enter the IP address you picked that is outside your router's DHCP range.
2. Do not change the subnet mask. The default setting of 255.255.255.0 is correct unless you have a very unusual home network.
3. Then enter your own router's address in the "Default Gateway" box. Note that the first 3 groups of digits should be the same as your camera's IP address. Usually the last digit is 1, sometimes it is 254.

**Note: It is very important to add the "Default Gateway" when assigning static local IP. While the camera gets this information automatically from the router when using DHCP, the camera will not obtain this information if a local IP address is assigned manually.**

4. Then click on "Use the following DNS server" and Leave DNS server settings blank or enter both the primary and secondary DNS addresses that you obtained from your router menu or from your computer's network connection menu.
5. HTTP/RTSP PORT: Leave it the default setting. The HTTP port is usually 80.
6. RTP port range: Leave it the default setting or enter the RTP port as below: The RTP port range should start at 30000 for your first camera. For all additional cameras the start of the range increase by 2, for example your 2<sup>nd</sup> camera would have a starting RTP port of 30002, the 3<sup>rd</sup> camera would have 30004, 4<sup>th</sup> camera at 30006 etc.

After you click on "Apply", you need to log in to the camera at the address you just picked. Remember to add the http:// in front of the IP address, as in <http://192.168.0.101>. If your port is not 80 you need to add the port too.

From now on, regardless of what computers or other devices you have on your own network and regardless of the order that you turn them on or off, your camera's IP address will always be the same.

On some routers, for example some older models of Leviton or NetGear, you may also need to tell your router about the network camera's IP address, so that it shows up as a known device on your network.



## 4.3.2 Manual Setup step 2: Configuring your router to allow access to your camera from the Internet (Without UPnP)

If you are not using UPnP or UPnP is disabled on your router, you will need to open a port on your router so that you can access your camera from the internet.

If you are unsure if UPnP is working on your camera, visit your camera Settings System page. Under UPnP port forwarding it will be labeled as “Success”, “Failed” or “Disabled”.

UPNP port forwarding	
Status:	Success
Gateway external IP address:	183.37.126.180
Gateway external port:	8150
Internet URL:	<a href="http://183.37.126.180:8150">http://183.37.126.180:8150</a>

Port forwarding is sometimes called “Virtual Server”, “user defined service”, or “port mapping” and is explained in your router’s manual or online help. The manual is usually available from the manufacturer’s tech support web site.

Firewall security features built into some routers may prevent the camera’s UPnP from configuring your router. Your router connects to the Internet over a series of “ports” and sometimes the default ports used by the camera are blocked from access over the Internet, therefore, these ports need to be made accessible. **This is achieved using the Port Forwarding function on your router.** The ports used by the camera must be opened through the router for remote access to your camera. Check the following website: <http://www.portforward.com/>

You typically need to enter the external (public) and internal (Private) ports(hosts) and select TCP.

**For browser access to the camera you need to forward public port 8150 to internal port (base port) 80. Your 1<sup>st</sup> camera would use TCP port 8150 to internal port (base port) 80 , Your 2<sup>nd</sup> camera would use TCP port 8151 to internal port (base port) 80 AND the 3<sup>rd</sup> camera would use TCP port 8152 to internal port (base port) 80.**

After these settings, your router typically needs to be restarted and then you’re ready to use the camera over the internet. First you need your router’s IP address on the internet (that’s NOT the local address that starts with 192.168). You can find this address by looking at your router’s WAN menu, or you can use [www.checkip.org](http://www.checkip.org)

A friend who is outside your local network should then be able to access your camera using this IP address and port 8150, as in <http://183.37.136.55:8150>

## 4.4 DDNS SETUP

### 4.4.1 DDNS SETUP Step 1---Choosing a Name for your Camera on the Internet

With typical residential internet service your router's IP address can change from time to time. Looking up the current IP address can be inconvenient, and buying a static IP address is an unnecessary monthly expense. [www.no-ip.com](http://www.no-ip.com) and [www.dyndns.com](http://www.dyndns.com) are the recommended companies for "Dynamic DNS" service. Also known as DDNS, this is a totally free service that allows your own name to be assigned to your camera. This name takes the place of the IP address. Together with software in your camera this also makes sure the name for your camera is always updated with the correct IP address.

First you create a free account with one or both of these companies. We'll take [www.no-ip.com](http://www.no-ip.com) as an example. The "create account" function is on the top right under the Username/ Password fields. Do not register a domain or sign up for any other paid services. You just need the free account.

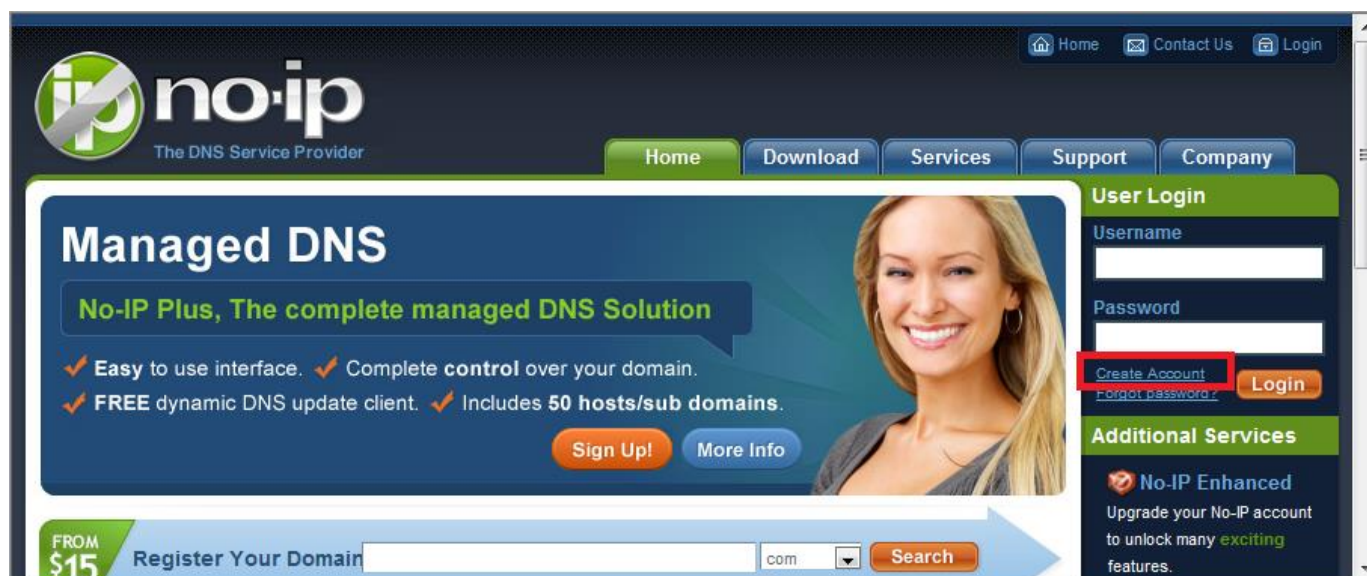

Once you have an account and once you validated it by responding to their email, log in and select "Hosts/ Redirects" on the top left of the screen, then "Add Host". For Hostname, pick anything you like as a name for your camera, except do not use spaces. Use only lower case letters and numbers. Then click on the domain names you can pick from, as well as some that they consider premium names worth paying for. For example, you could pick **servehttp.com** as your demo cameras.

Then be sure that only "DNS Host (A)" is selected. Don't worry about the current IP address and don't change anything else. Click on "Create Host" and you're done! Please write down your complete hostname as well as the username and password you used for logging in to No-IP.com as you'll need it for the next step.

DynDNS.com is very similar but in their case there is an additional step of checking out a shopping cart with a zero dollar fee.

Now proceed to the next section to make sure your name is updated correctly.

## 4.4.2 DDNS SETUP 2--Automatic Updating of your Camera's Internet IP address

In the previous step we set up a name for your camera. To make sure that this hostname always corresponds to the correct IP address for your camera we have to make sure it is updated automatically when there is a change.

Dynamic DNS (DDNS) is simply a way of using a static hostname to connect to a dynamic IP address. When connected to your ISP, you are assigned a temporary IP address. DDNS services keep track of your IP address and route your Domain name to that address when you wish to connect to the camera from a remote location.

There is no need for client software. Our IP cameras have a DDNS menu that allows you to enter your hostname information. This DDNS menu is under "Network" in the camera's "Settings". Be sure to select the DDNS provider, for instance if you signed up with No-IP.com you should select No-IP in the camera's DDNS menu.

The screenshot displays the TRIVISION camera's web interface for DDNS Setup. The main content area includes a 'DDNS Setup' section with the following fields and options:

- DDNS:** Radio buttons for 'Enable' (selected) and 'Disable'.
- Service provider:** A dropdown menu showing 'no-ip.com' with a 'Register' link next to it.
- Host name:** A text input field containing 'trivisionipcamera.servehttp.com'.
- User name:** A text input field containing 'ipcamerastore'.
- Password:** A password input field with masked characters.
- Re-type password:** A second password input field with masked characters.
- Apply:** A button at the bottom of the form.

The right sidebar contains a navigation menu with the following items:

- Camera
- Network (expanded)
- Wireless Setup
- TCP/IP Setup
- DDNS Setup (highlighted with a red box)
- UPNP Setup
- P2P Setup
- Storage
- Task
- Tools

**[DDNS]** Enable or disable DDNS connection. Click "Enable" for the rest of the options to appear.

**[Service Provider]** Select a provider from the drop down list then click "Register". This will take you to the service provider's website where you can register your own personal host name. Please follow the instructions on the provider's site, and then return to this page to enter the details.

**[Host Name]** Enter the host name you have registered (e.g. yourname.dtdns.net).

**[User Name]** Enter the user name for the account you registered with the service provider.

**[Password]** Enter the password for the account you registered with the service provider.

**[Re-type password]** Re-confirm the password.

Now you have setup an easily accessible external address for your camera, you now need to setup and confirm an external port for your camera. This is covered in the UPnP section.

**Please note: if you have only just registered your DDNS account, it may take a while your account is activated and full registered on the internet. Some of the DDNS service listed offer free paying service. A free account is more than adequate for a camera to use.**

After you enter your account and hostname information and UPnP is enabled, you can go to the camera's "System" menu at the top of the Settings screen and scroll down to the DDNS section. If it worked, the camera's external address will be listed under "Internet URL".

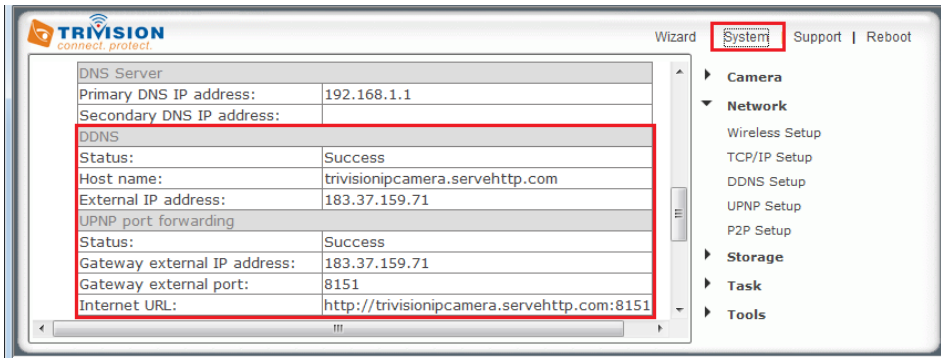

If it says “Updating” or Unavailable” you should double check your account settings. No-IP.com uses your complete email address as user name, and the password required in this menu is the one you created during No-IP account setup. If successful the camera will show you the complete external URL for your reference.

The external address using DDNS is made up of two parts – your DDNS account address and the port you opened via UPnP or manually.

**For example:** DDNS Host name account: <http://yourname.dtdns.com> Port: 8150

So with the above information, your camera would have the address of: <http://yourname.dtdns.com:8150>

Open any internet browser on your computer, and type **your own DDNS account name**, followed by **:8150** (that’s a colon, followed by 8150). After a few moments, your Camera Homepage should be displayed. You can then login to view your camera or change your settings as normal.

To confirm your own external camera address, stay within the Settings menu, and click on “System” at the top right of the screen. This will list various settings of your camera. Under UPNP Port Forwarding, it should list your cameras hostname and port.

**Note: Only 1 single camera per network needs the DDNS setup. This enables access to the entire network.**  
**Important Notes**

- 1) If you try to access your own camera(s) from your home using the external IP address it may not work. Some internet service providers recognize that you are trying to do something that usually doesn’t make sense. Their routers may block requests that go from your network out to the internet and then loop back to your own network.

Therefore we always recommend that you get in touch with a friend to help you test the remote access to your camera from outside your own network. Or you can use an iPhone in 3G mode (Wi-Fi turned off)

- 2) Once your camera is live on the internet, you should change the admin password to something only you would know. See the “User management” menu under “Tools” section of your camera’s “Settings” screen. Only admin can change settings. If you add other user names they can only see video without changing anything.

If you forget your password you can always reset your camera to factory settings using the reset procedure shown at the end of this manual.

## 5.0 Positioning and Mounting

**Indoor cameras:** The included desktop stand can also be used for wall or ceiling mounting. For some angles you may need to loosen the main mounting ring by turning the big flat screw on the back of the bracket with a coin, so that the notch in the mounting ring allows the pin to point in the desired direction. You can then tighten it again with the coin. Should any mounting position require the image to be rotated 180 degrees (inverted), there is a setting for that in the “camera setup” menu.

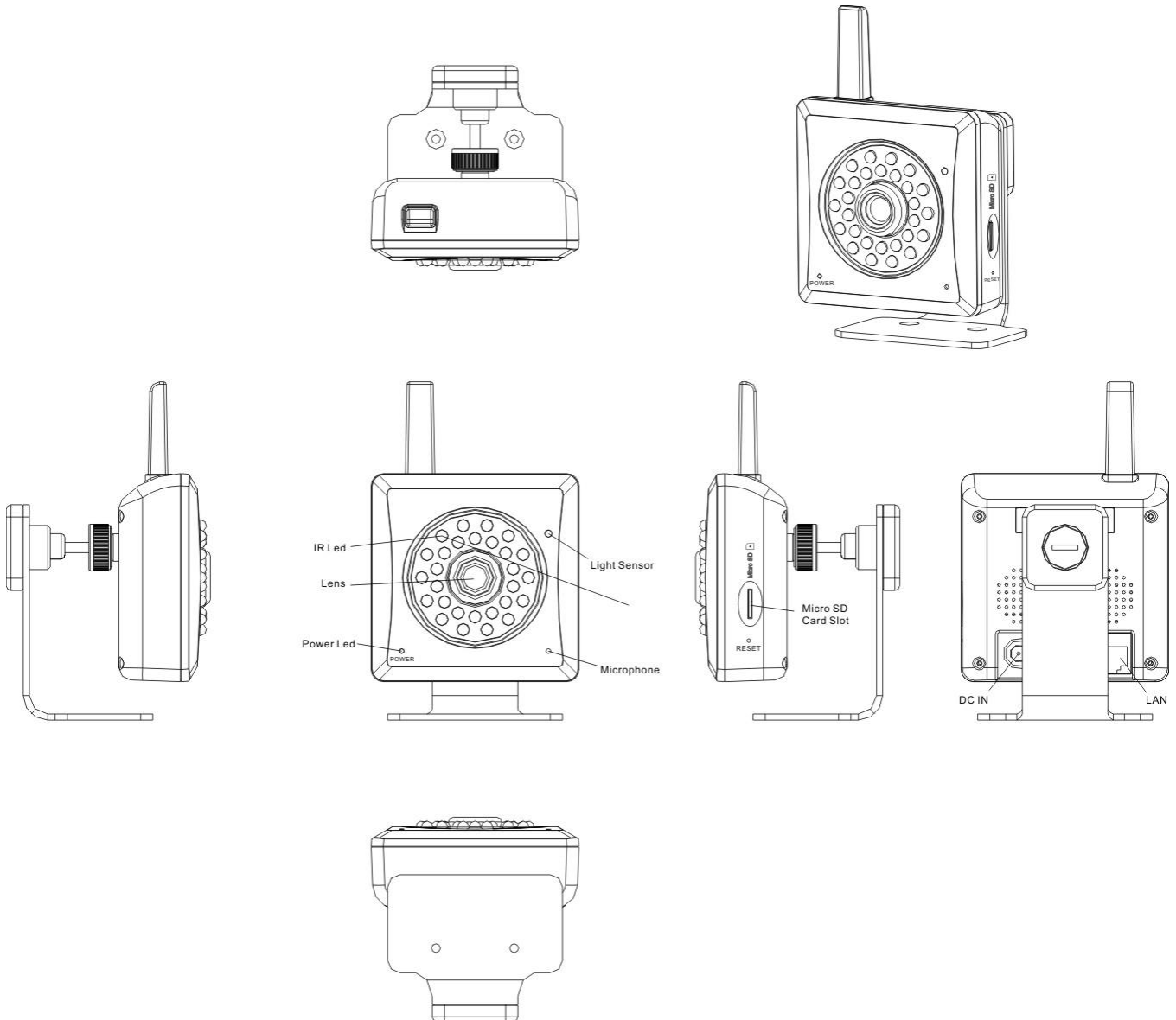

Loosen the set screw at the side of the bracket with the included hex wrench to allow adjustment of the angle. To mount the camera under an overhang, you can replace one of the sunshade mounting screws with the included special mounting nut to allow attachment of the camera bracket from above.

Please note that the sunshade can be mounted in several positions depending on your needs. If it extends forward it can do a better job reducing glare from the sun as well as keeping the lens glass dry in light rain or snow. On the other hand, reflections of IR light from the underside of the sunshade would make the entire picture appear foggy, so for maximum night vision range you would either move the sun shade all the way back or remove it entirely.

**Outdoor cameras: Before mounting, you should first become familiar with the camera indoors. Once installed. Cameras cannot be returned for refund.**

The outdoor cameras are completely weatherproof including the connection box at the wire ends. If not fished through a wall, the wire ends can be placed inside the small metal waterproof electrical box. This also helps simplify further connections to optional equipment such as an alarm system, control relay, or amplified speakers for the new bi-directional audio feature. See connection details towards the end of this User Guide.

Please note that after initial setup only the power cable is required for the Wi-Fi outdoor camera. The POE outdoor camera can be either connected with power cable and Cat5, or optionally just with a Cat5 cable that is connected to an 802.3af POE compatible switch or router. We recommend the NetGear FS108P switch.

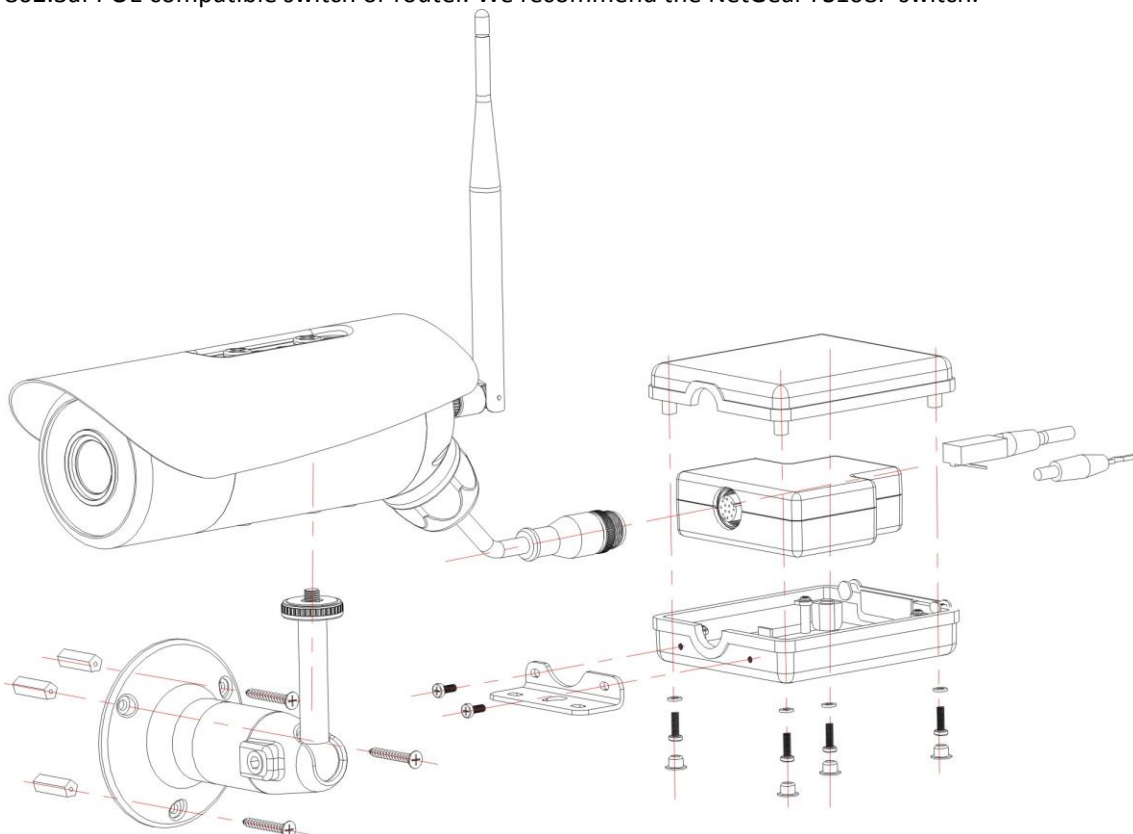

### Extension BOX Interface

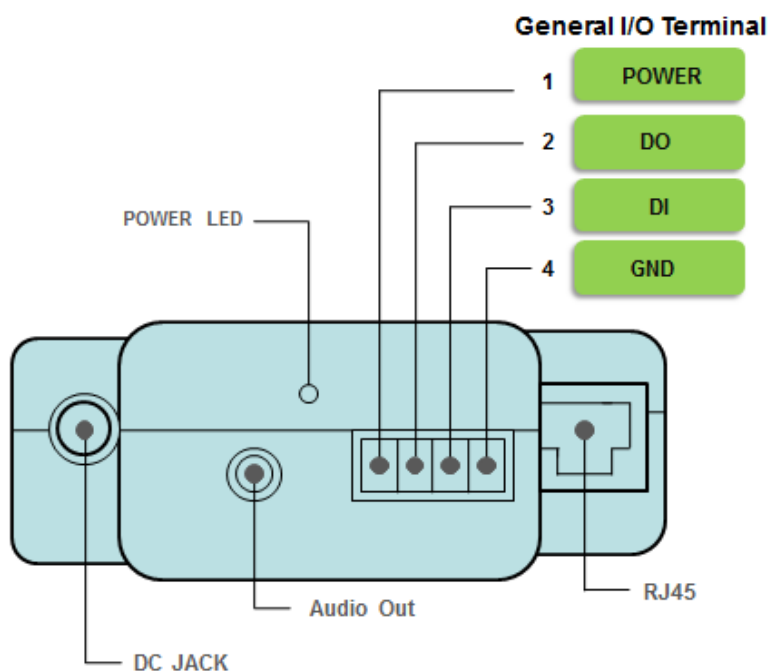



# 6.0 CAMERA SETTINGS

## 6.1 Login Password Modification

You can now view your camera live, but this is only on your local network, so you can now refine and customize the settings of the camera. To continue with camera customization, access your camera's Settings page by clicking on the "Settings" word from your Live View, or click on the word "Settings" from the Camera Homepage.

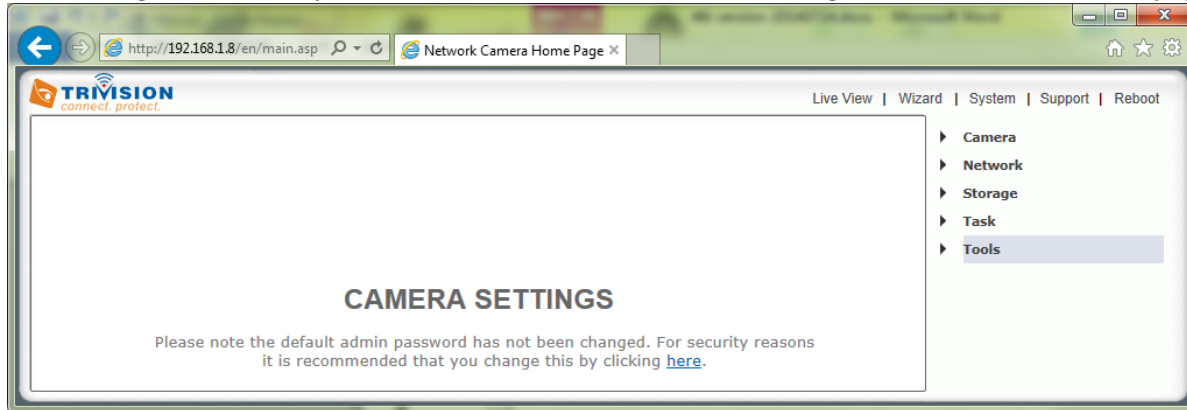

**Please note: If you are installing the camera for the first time or after a reset to factory defaults, you are advised to change the cameras default password as per the message displayed.** Changing the cameras default password is **highly recommended** to stop unauthorized access to your camera.

## CAMERA SETTINGS

Please note the default administrators password has not been changed. For security reasons it is recommend that you change this by clicking [here](#).

Click the link displayed to access the Administrator Password editing page.

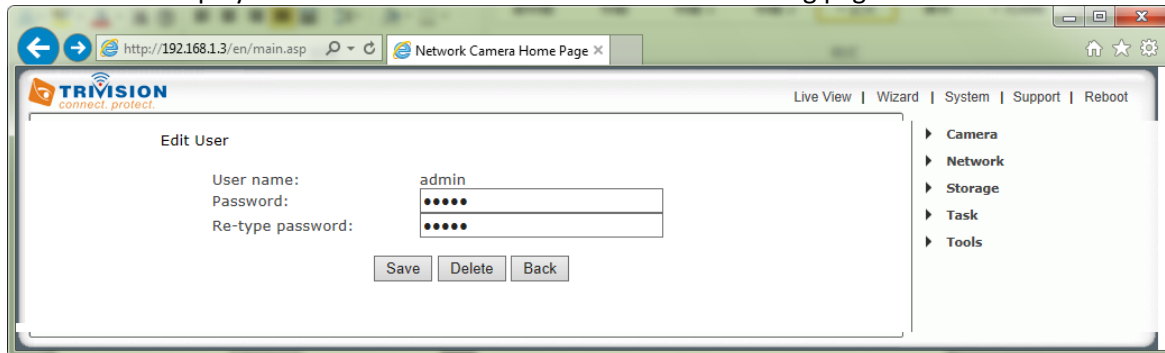

The Administrator username is always "admin" in lowercase. Choose a password that is memorable only to you – **avoid** passwords that are easy to guess, such as "password" "admin" "123456" or your personal details.

**Please note: Keep this password safe. The only way to recover from a lost password is to reset the camera back to its default settings, and this will wipe all other settings**

Once you have typed your password twice, click Save. The system will then ask you to login again. You should then see the following screen:

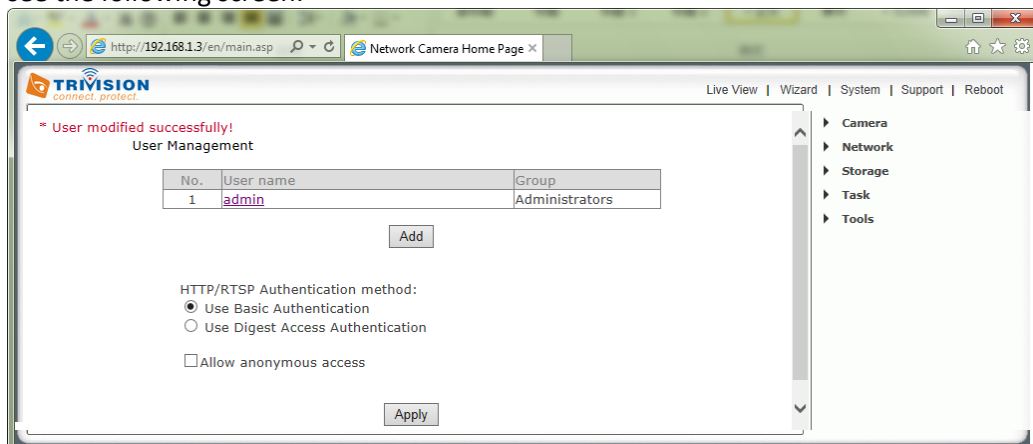

## 6.2 Quick Setup with the Wizard

To make the setup process slightly quicker for users, we have created a Setup Wizard which takes you through common options to getting your camera setup wirelessly and with your custom settings.

Within the Settings screen, click on “Wizard” in the Header Menu.

The Wizard will launch in a new window. Follow the simple instructions on the screen and enter the required details, clicking next to proceed through each step.

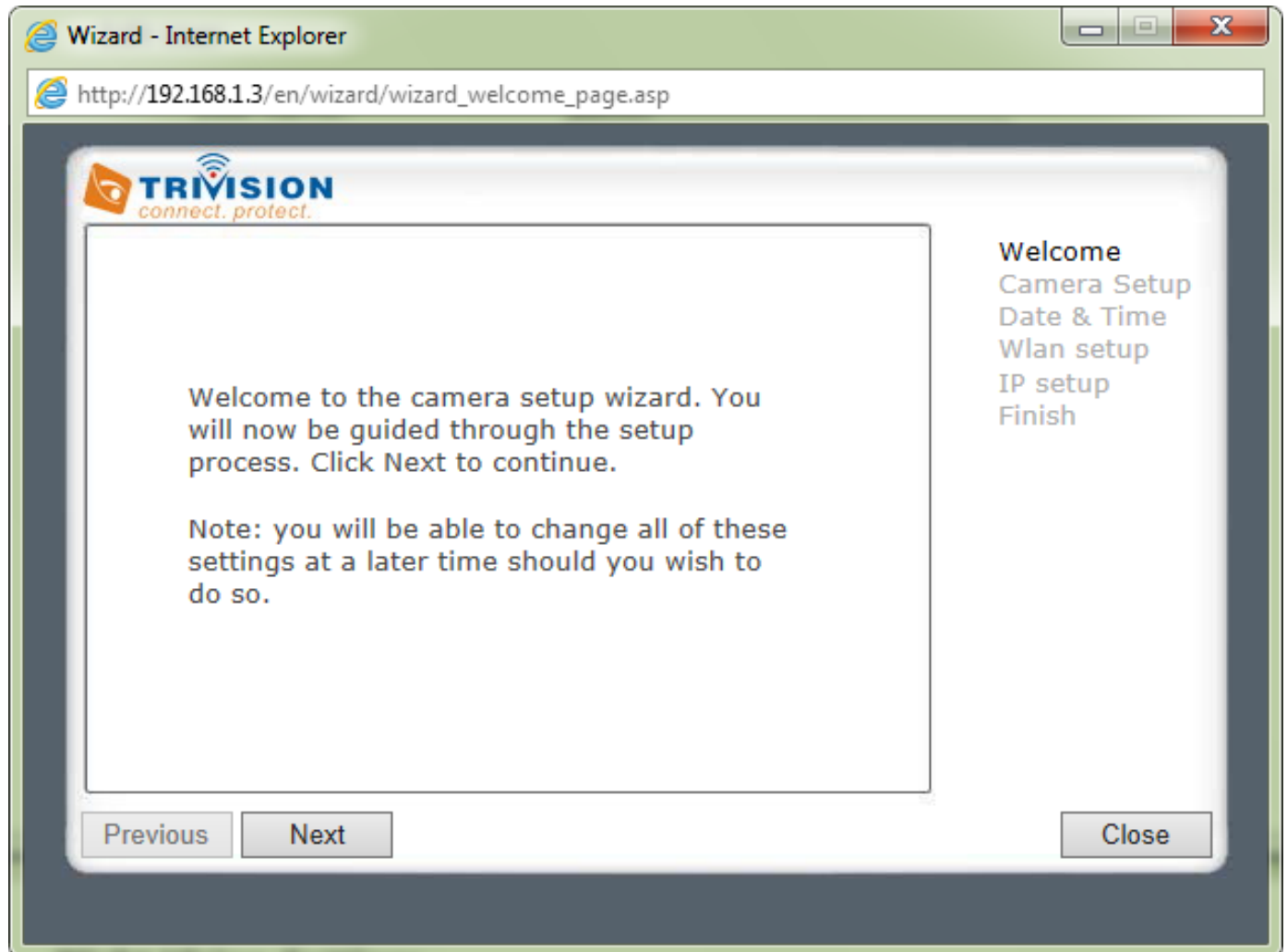

With this Wizard, you will be able to set the:

- Name of Camera**
- Quality of Picture you wish to view**
- Time Zone**
- System Time**
- Wi-Fi Setup**
- TCP/IP Setup**

This should help you get your camera setup and working very quickly at a basic level.



## 6.3 System Page

From within the Settings menu, clicking on “System” at the top right will list the system information of your camera. This screen is one of the most useful in the camera Settings. This screen lists information you may need if you want connect to your camera from other systems. It’s a great way to check if your camera has all the details needed to operate correctly.

**Firmware Version** – Your current firmware version. Check the [trivisiontech.com](http://trivisiontech.com) website or contact our technical support: [info@trivisiontech.com](mailto:info@trivisiontech.com) to see if there are updates for your model

**Wireless** – The current status and strength of your wireless connection if in use.

**IP address** – The internal IP address of your camera so you can access it on your local network.

**DNS Servers** – If this option is empty, it may prevent your camera from sending email alerts. Enter the DNS in the TCP/IP menu if needed.

**DDNS** – If you do not have a static IP address, a DDNS service helps you access your camera easily from outside your network. This confirms the DDNS is active or not.

**UPNP** – If your router has UPNP and it has successfully worked with your camera, this will tell you here. This saves you forwarding any ports.

**Internet URL** – This is the external address and Port of the camera.

**P2P**-This is the fast and simple remote access solution on PC, Mac, IOS, Android, please check the Quick Guide for the detail of installation.

**Storage** – Lets you know if storage is available on SD card or NAS drive.

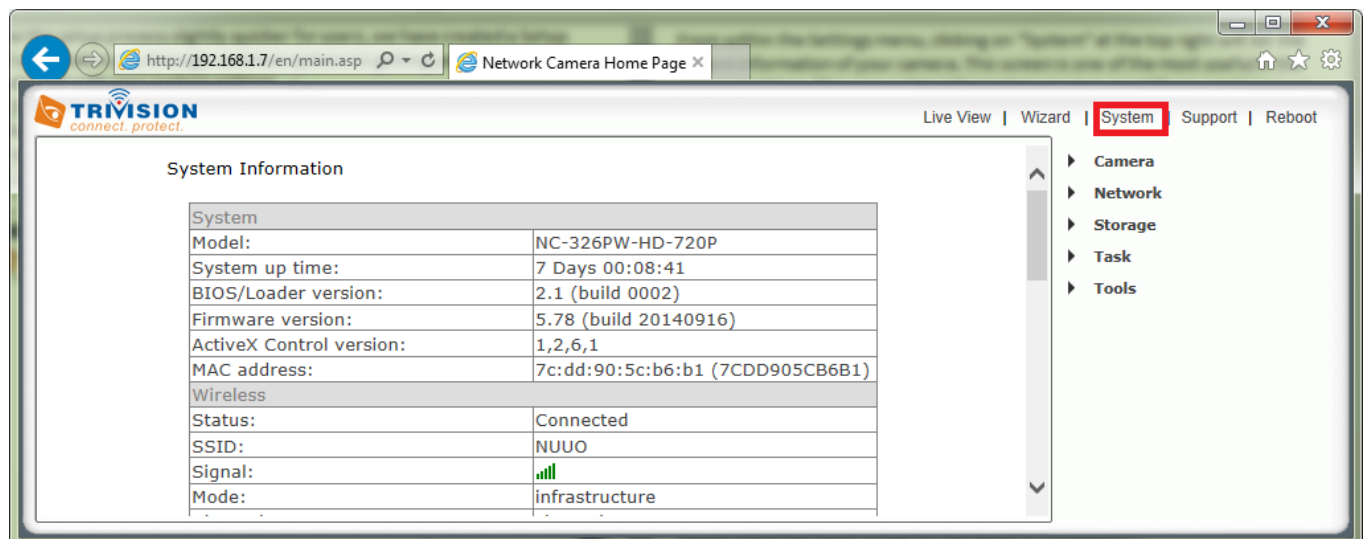

The screenshot shows the Trivision camera's web interface. The browser address bar displays <http://192.168.1.7/en/main.asp>. The page title is "Network Camera Home Page". The navigation menu at the top right includes "Live View", "Wizard", "System" (highlighted with a red box), "Support", and "Reboot". The main content area is titled "System Information" and contains a table with the following data:

System	
Model:	NC-326PW-HD-720P
System up time:	7 Days 00:08:41
BIOS/Loader version:	2.1 (build 0002)
Firmware version:	5.78 (build 20140916)
ActiveX Control version:	1,2,6,1
MAC address:	7c:dd:90:5c:b6:b1 (7CDD905CB6B1)
Wireless	
Status:	Connected
SSID:	NUUO
Signal:	
Mode:	infrastructure

## 6.4 Reboot

Click Reboot in the Header Menu to access the Camera Reboot page to restart the camera. Rebooting the camera will retain all the settings and configurations.

A reboot is normally necessary when you insert a microSD card into the camera.

## 6.5 Camera Menu

### 6.5.1 Camera Setup

The Camera menu is located on the right of the Settings screen. When you click on the word “Camera”, a sub-menu of camera setup options will be displayed.

For most users, many of these settings can be left as default.

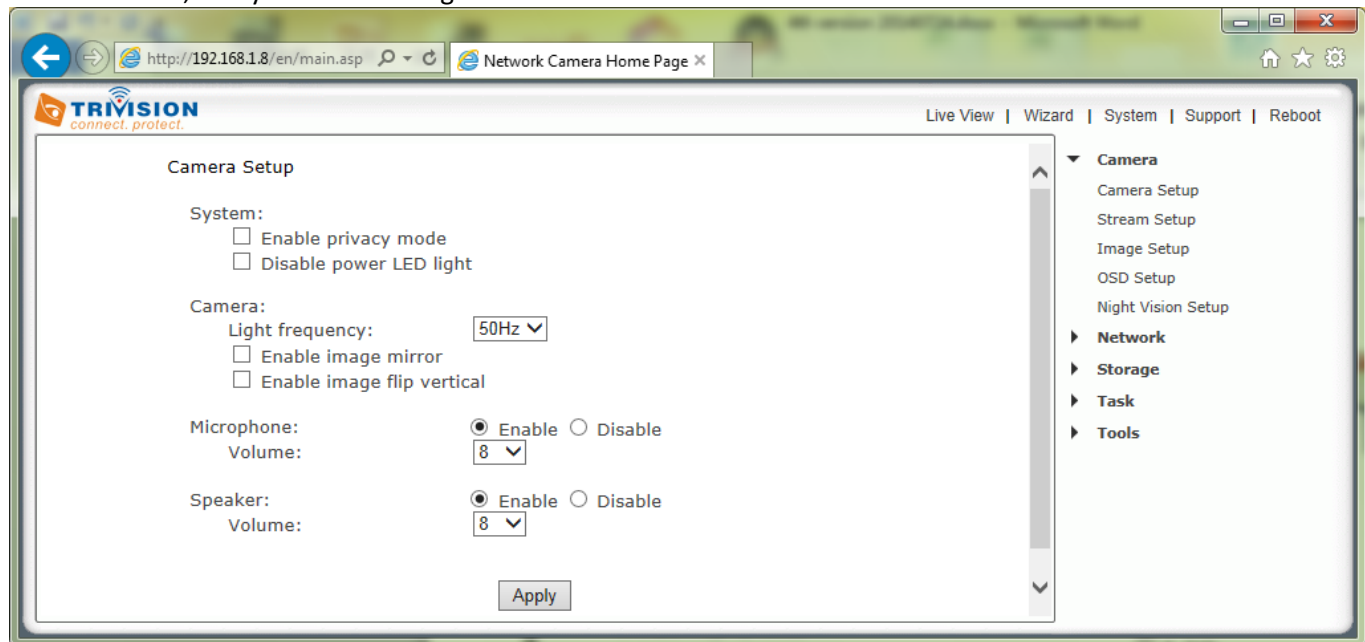

#### Camera Setting Options

##### System:

**[Enable privacy mode]** Videos will not be seen.

**[Power LED light]** Turns off the camera front LED on or off

##### Camera:

**[Light Frequency]** Two options: 50Hz & 60Hz. This should be set according to the mains frequency of the country the camera is being used in. For EU this would be 50Hz. For the USA this would be 60Hz.

**[Enable image mirror]** Display a mirrored view of the video.

**[Enable image flip vertical]** Display video upside down – useful if you have installed the camera upside down.

##### Microphone:

**[Microphone]** Enables or disables the built-in microphone.

**[Volume]** Adjusts the sensitivity of the microphone from 0~10 where 0 is the lowest.

Click **Apply** to confirm your setting.

## 6.5.2 Stream Setup

Click on Stream Setup under the Camera Menu to change the streaming settings for your camera. This is useful if you require a certain size of video stream, a certain quality, or different streams for different devices (such as laptop or mobile phone).

Default settings will normally suffice for most users.

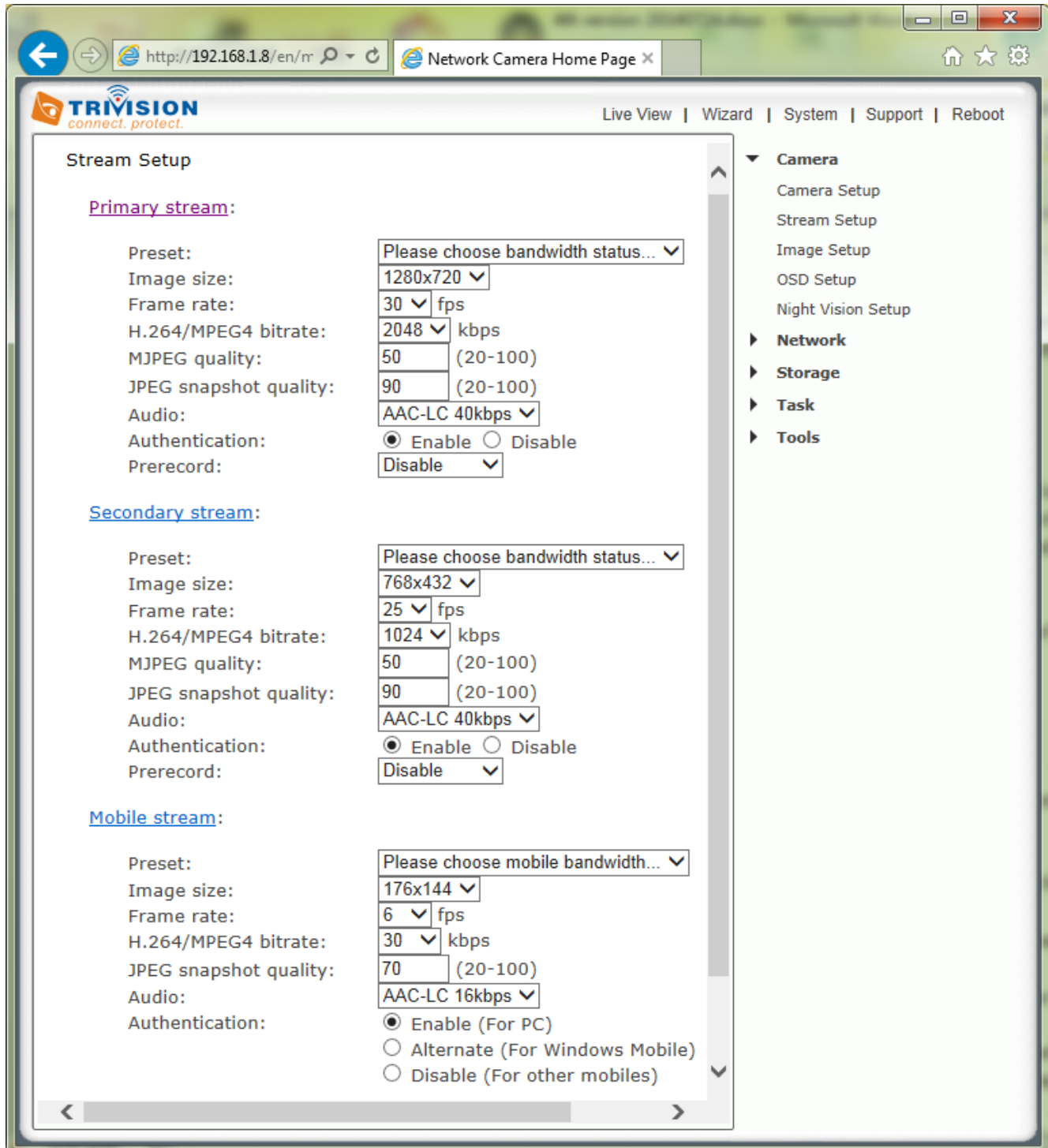

There are a number of video streams available. You can configure settings for the primary and an optional secondary video stream. Configuring a secondary stream is useful for providing a video stream that is at a lower resolution than the primary stream to third-party devices or software. Some devices and software require lower resolution.

The Mobile stream is similar to the first two streams but is purely for mobile viewing and has a fixed resolution.

# Stream Setting Options

**[Present]** There are five pre-programmed stream profiles for quick set-up. Please choose the one according to your bandwidth.

**[Image size]** Image resolutions available are as follows:

**480P Model:** 640 x 480(VGA), 320 x 240(QVGA), 160 x 120 (QQVGA). The mobile stream has a fixed image size of 176x144.

**HD 720 Model:** 1280x720 (HD720p), 768x432, 512x288, 256x144). The mobile stream has a fixed image size of 176x144.

**HD 1080 Model:** 1920x1080 (HD1080p), 1280x720 (HD720p), 768x432, 512x288, 256x144. The mobile stream has a fixed image size of 176x144.

**[Frame rate]** Twelve options: 1/2/3/4/5/6/8/10/15/20/25/30 frames per second (fps). The frame rate is automatically determined by the camera and this depends on the network bandwidth available at the time. This frame rate setting imposes the maximum frame rate that the camera will transmit.

**[H.264/MPEG4 bit rate]** Select H.264/MPEG4 bit rate. These settings determine the image quality, however higher bitrates require greater bandwidth. Please select the appropriate settings according to your connection speed and network traffic. If you are experiencing jerky video it may be necessary to decrease the bitrate.

**[MJPEG Quality]** This sets the quality of the video when viewing the camera using Motion JPEG (without audio). It can be from 20 to 100 where 100 is the best quality.

**[JPEG snapshot Quality]** The quality of the snapshot saved using Live View page (Internet Explorer only). It also affects the quality of the snapshot to be uploaded to an FTP Server. It can be from 20 to 100 where 100 is the best quality.

**[Audio]** Select or disable the audio bit rate.

**[Authentication]** Select or disable MPEG4 RTSP authentication.

Clicking on the name of the stream will display various paths to the paths to the particular video stream

Primary Stream List

Intranet stream URL	
RTSP H.264 stream:	rtsp://192.168.1.7:80/live/0/h264.sdp
RTSP MPEG4 stream:	rtsp://192.168.1.7:80/live/0/mpeg4.sdp
RTSP MJPEG stream:	rtsp://192.168.1.7:80/live/0/mjpeg.sdp
RTSP audio stream:	rtsp://192.168.1.7:80/live/0/audio.sdp
HTTP M3U8 stream:	http://192.168.1.7:80/live/0/h264.m3u8
HTTP MJPEG stream:	http://192.168.1.7:80/live/0/mjpeg.jpg
HTTP snapshot image:	http://192.168.1.7:80/live/0/jpeg.jpg
RTMP H.264 stream:	rtmp://192.168.1.7:80/live/0/h264.flv

Internet stream URL	
RTSP H.264 stream:	rtsp://183.37.126.180:8150/live/0/h264.sdp
RTSP MPEG4 stream:	rtsp://183.37.126.180:8150/live/0/mpeg4.sdp
RTSP MJPEG stream:	rtsp://183.37.126.180:8150/live/0/mjpeg.sdp
RTSP audio stream:	rtsp://183.37.126.180:8150/live/0/audio.sdp
HTTP M3U8 stream:	http://183.37.126.180:8150/live/0/h264.m3u8
HTTP MJPEG stream:	http://183.37.126.180:8150/live/0/mjpeg.jpg
HTTP snapshot image:	http://183.37.126.180:8150/live/0/jpeg.jpg
RTMP H.264 stream:	rtmp://183.37.126.180:8150/live/0/h264.flv

Back

## 6.5.3 Image Setup

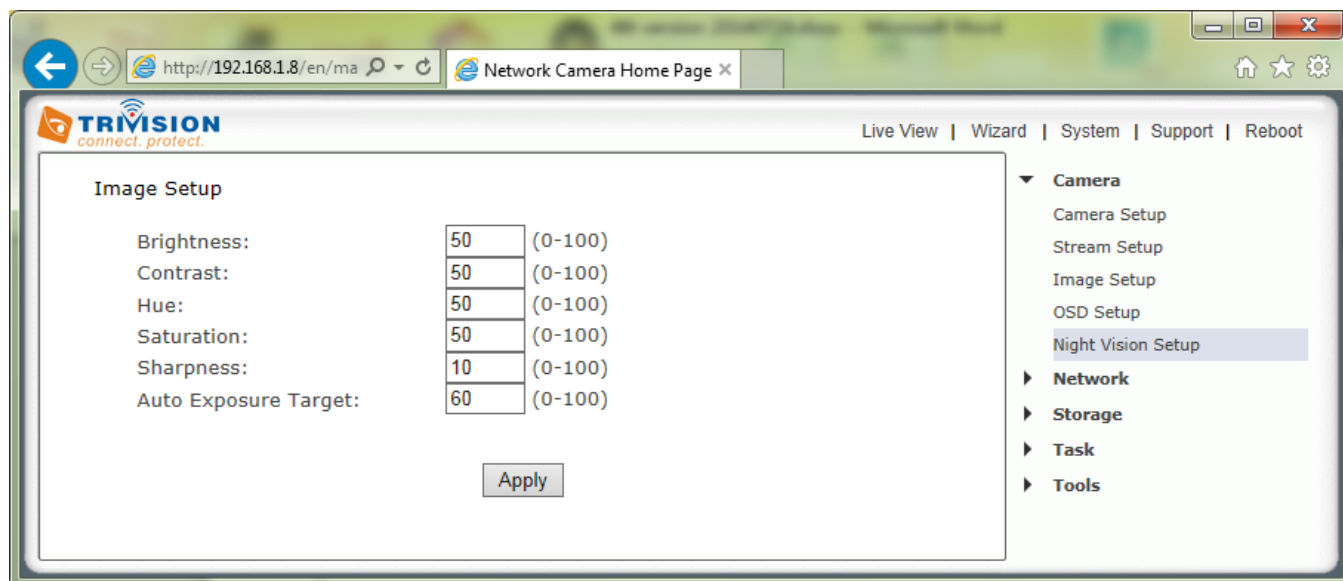

**[Brightness]** make the image brighter or darker by a specified amount. When increasing brightness, you may find that you lose some contrast on the brightest details in the image while the rest of the image has the same contrast as before.

**[Contrast]** Contrast is defined as the separation between the darkest and brightest areas of the image. Increase contrast and you increase the separation between dark and bright, making shadows darker and highlights brighter. Decrease contrast and you bring the shadows up and the highlights down to make them closer to one another. Adding contrast usually adds "pop" and makes an image look more vibrant while decreasing contrast can make an image look duller.

**[Hue]** Change is similar to rotating a color wheel to select a different mixture of colors

**[Saturation]** Saturation is similar to contrast, however instead of increasing the separation between shadows and highlights, we increase the separation between colors.

**[Sharpness]** Sharpness can be defined as edge contrast, that is, the contrast along edges in a photo. When we increase sharpness, we increase the contrast only along/near edges in the photo while leaving smooth areas of the image alone.

**[Auto Exposure Target]** Automatic exposure (abbreviation: AE) mode automatically calculates and adjusts exposure settings to match (as closely as possible) the subject's mid-tone to the mid-tone of the photograph. Exposure is a combination of the length of time and the illuminance at the photosensitive material. Exposure time is controlled in a camera by shutter speed and the illuminance by the lens aperture and the scene luminance. Slower shutter speeds (exposing the medium for a longer period of time), and greater lens apertures (admitting more light), and higher-luminance scenes produce greater exposures.

## 6.5.4 OSD Setup

Click on OSD Setup under the Camera Menu to change the on-screen display parameters of the camera.

### On Screen Display Setting Options

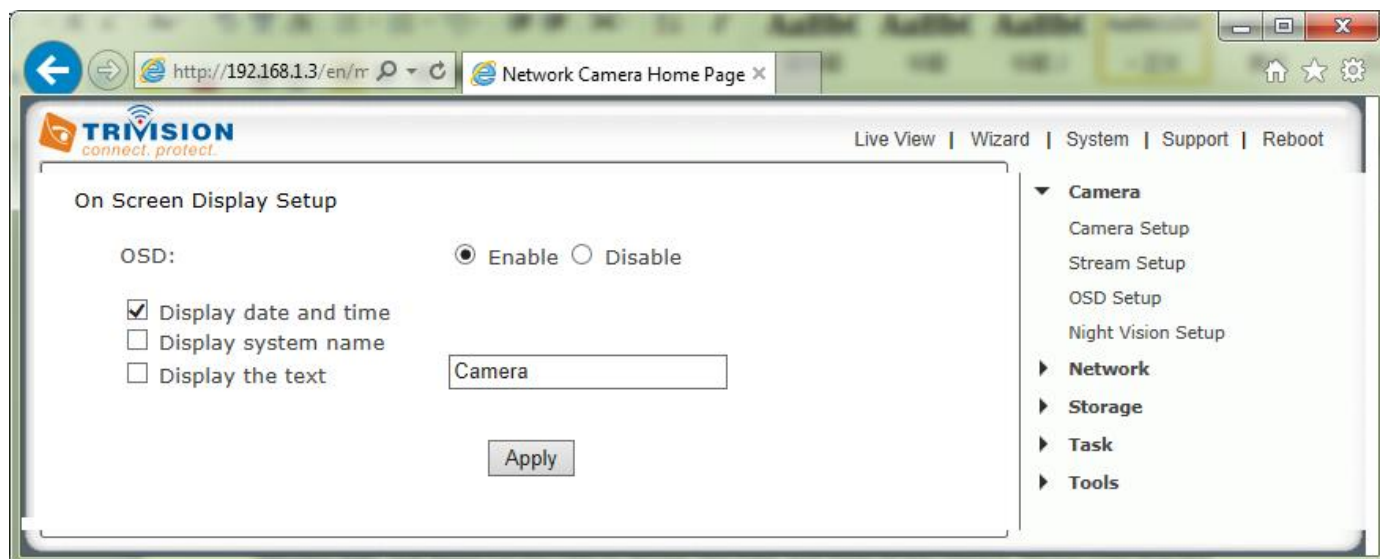

**[OSD]** Enable or Disable the On Screen Display.

#### OSD Options

**[Display date and time]** Set the OSD to display the Date and Time of the camera. Please note that this function will simply display the date and time that has been programmed in the camera and therefore the time and date may be incorrect unless the camera is synchronized to a time and date server on the internet. This is accessible under the Tools menu and will be covered in more detail in the manual.

**[Display system name]** Set the OSD to display the System Name of the camera. The system name can be modified from the System Identity page, accessible under the Tools menu, and will be covered in more detail in the manual.

**[Display the text below]** Set the OSD to display specific text. Use the text field to input the desired text.

Click **Apply** to confirm your setting.

## 6.5.5 Night Vision Settings

At night, with the infra-red lights, the cameras simply show reflected light. If the camera is pointed at empty space (not pointed at trees, grass, or other objects), the night time picture will be entirely black. The infra-red lights seem to project out roughly 50 feet - of course at that distance at night it will be difficult to pick out many details about the object that is recorded.

If there is ambient lighting (street lights, overhead security light, infra-red light provided by other cameras or external IR emitter) it is possible to extend the night time visible area.

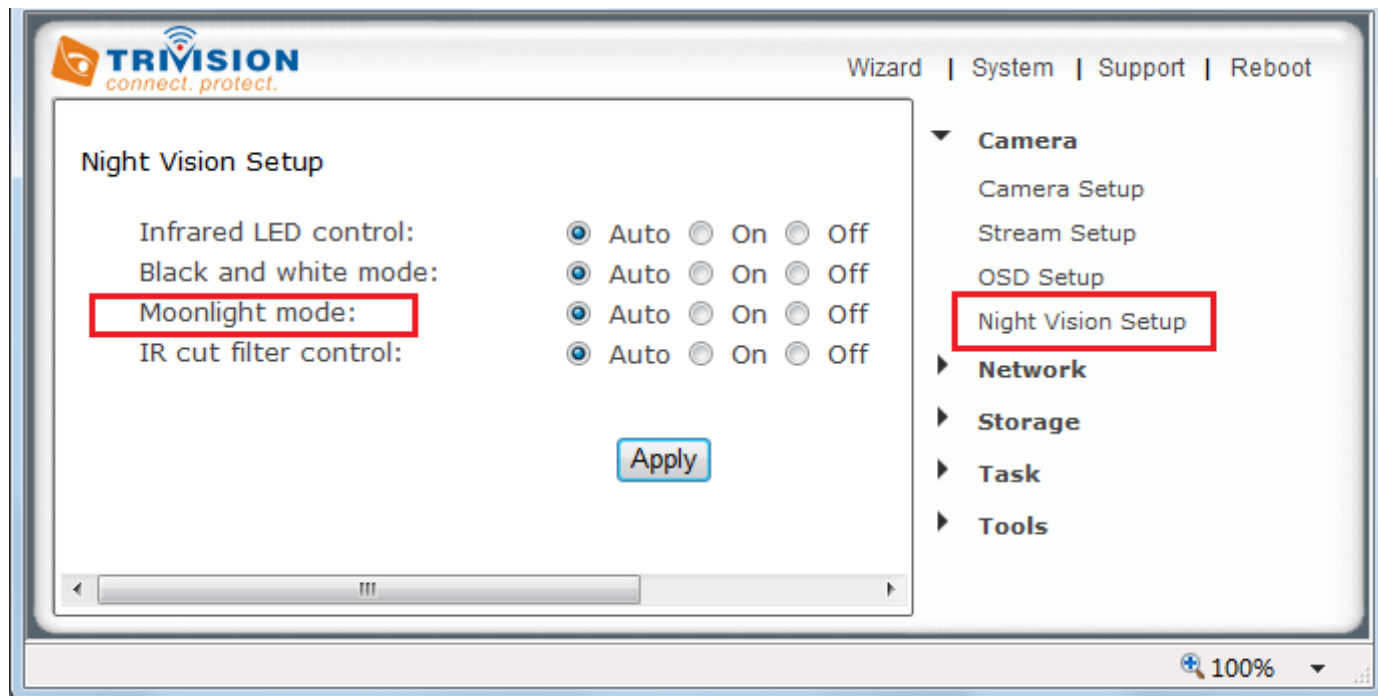

1. The " **Infrared LED control**--"Auto" switches on the IR LEDs automatically when there isn't enough light to produce a good quality image. "On" turns the IR LEDs on permanently and ignores the light level in the room (resulting in a Black & White mode). When "Off" is selected the IR LEDs are kept in the off state even if the light level of the room is too dark to produce a good quality image. This may be useful if the LEDs are reflecting off a nearby surface and obstructing your view.  
*Please note: "Auto" uses the light sensor on the front of the camera to check ambient light level to turn on the IR LEDs at night. The sensor is below the lens.*
2. " **Black & White Mode**"-- "Auto" switches the video from color to monochrome when the IR LEDs are turned on. "On" switches the video to monochrome irrelevant of the status of the IR LEDs. "Off" forces the camera to stay in color mode even when the IR LEDs are on. The default setting is "Auto" so that you have the highest sensitivity at night. In many environments you have better picture quality as well as color night vision with ambient light if you set this setting to "Off", so you may want to try it.
3. " **Moonlight mode**"-- Turns Moonlight mode on or off or set it to automatic. The Moonlight feature superimposes frames in order to brighten the image being viewed. This is also known as frame integration. In "Auto" the camera uses the front Light Level Sensor to detect the amount of light available to the camera. Should the light level below, the camera would automatically turn this feature on. **Moonlight mode** boosts the available light by reducing the frame rate to 7.5 fps. When "Moonlight model" is "auto" or "On", the cameras produce gorgeous night vision, especially the outdoor serials.





*With LED and Moonlight mode "OFF"*



*With LED and Moonlight mode ON or Auto*

**Please note:** If you are using the cameras to look through a window, you should set the night vision mode to turn off the IR LEDs instead turn on the automatic moonlight mode. Otherwise the IR LEDs would reflect off the window glass and the glare would make everything almost invisible.

4. **"IR Cut Filter control"**-- IR is present naturally in day light, this can cause discolouration of images where the greens can look purplish. The IR cut filter blocks these IR lights from coming back onto the lens of camera, and this gives a true day image. However, if the IR cut filter is on during night, the night vision will not work.

It is recommended to leave the IR cut filter control to **Auto** at all times, to achieve best results from the camera. During the day, an optical "IR Cut filter" removes all IR light. This makes the camera's vision similar to a human eye which does not see IR light, and therefore all colors appear vivid and natural to us. At night, the filter moves out of the optical path to enable IR night vision. You can actually hear a muted click when this filter moves in or out. This happens both during power-up and when light levels change between day & night.

## 6.6 Network Menu

The Network menu is located on the right of the Settings screen. When you click on the word "Network", a sub-menu of network setup options will be displayed.

**Skip the wireless setup chapter, please check page 18 to 21.**

**Skip the TCP/IP setup chapter, please check page 25 to 26.**

**Skip the DDNS setup chapter, please check page 28 to 30.**

**Skip the UPnP setup chapter, please check page 23.**

**Skip the P2P setup chapter, please check QuickGuide.**



# 6.7 STORAGE

## 6.7.1 Storage Setup

When the camera powers up with a Micro SD present in the slot, Enable “storage” and select store to “SD card”, and then select “format the Micro SD”.

The Storage menu is located on the right of the Settings screen. When you click on the words “Storage”, a sub-menu of options will be displayed

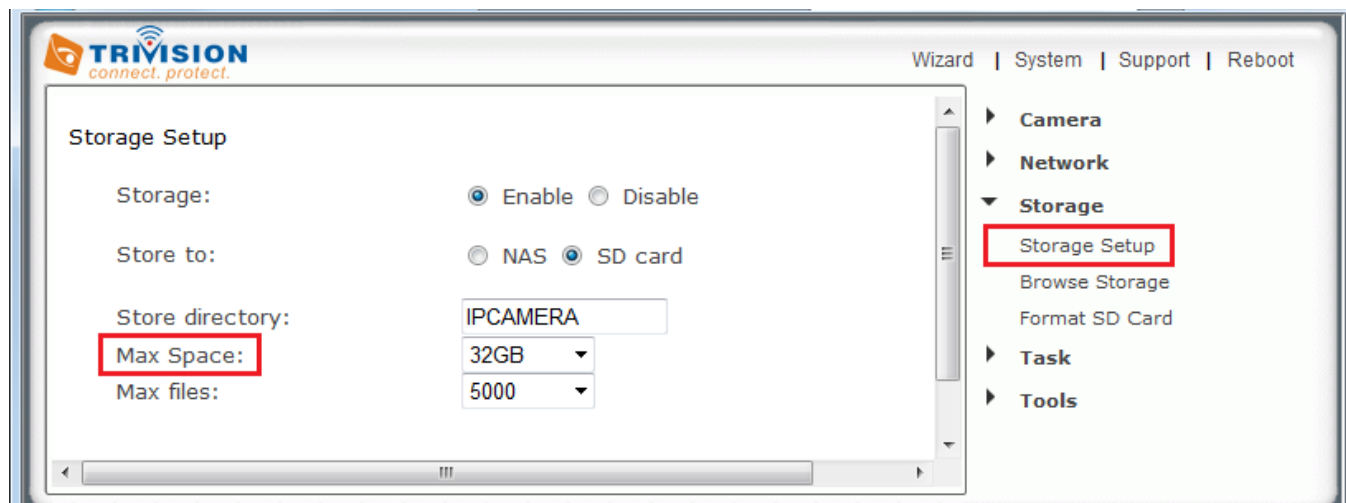

The camera can record video direct to virtually an NAS drive or to its internal microSD memory card.

**[Storage]** Select Enable to enable storage option.

**[Storage Select]** Select whether you want to record on NAS or microSD card.

**[Store directory]** This is the folder that videos will be saved to.

**[Max Space]** Storage capacity the camera will use on the chosen storage.

**[Max files]** The maximum number of files for all the videos can be recorded before overwriting.

Click **Apply** to confirm your setting.

## 6.7.2 MicroSD Card Information and Installation

Adding a Micro SD to your camera will allow you to record footage and motion alerts direct to memory card for future review.

**Please note: It is advised to insert the microSD card before any other setup begins as the card will not be recognized if inserted once the camera is turned on. Every time the card is re-inserted, you will need to turn the power off and then on again for the card to be recognized.**

**If you do not have a microSD card, but plan to add one later**, this is fine. When inserting the card, remember to turn the power off from the camera, insert the card, and then power it back on.

The camera officially supports microSD memory cards with capacities up to 128GB, including those labelled "SDHC".

It is required to install the SD card into the camera and format it within the camera. This option can be found under the Storage menu.

### MicroSD Important Notes and Information

1. There is a limit to the number of rewrites possible on any MicroSD memory card. If you notice the card becoming slow or sluggish after a reasonable usage, you will probably need to replace the microSD memory card. You should try to avoid purchasing second-hand memory cards.
2. If the card is not recognized by the camera, try formatting the microSD card via your computer and then trying it again in the camera.
3. Images may not be recorded or read correctly if an unsupported MicroSD memory card is used with the camera.
4. Carefully read the User guide, precautions on use, and any other information that was supplied with the memory card when purchased.
5. Do not use a memory card containing data recorded by another device as this may result in the camera not functioning correctly.
6. Do not modify, overwrite the data, or change the folder names of the MicroSD memory card. It may result in the camera not functioning correctly.
7. Always turn the power off to your camera before removing the microSD memory card.
8. Trivision Tech., LLC cannot be held liable for any loss of data or product misuse.

## 6.7.3 MicroSD card installation

The MicroSD card is not included in packages. The slot for the Micro SD card is at the right side of the indoor cameras and behind the lens cover on outdoor cameras. (See diagram below). The card can only be inserted into the camera with the golden pins of the microSD card facing the front of the camera. The SD card should not be forced into the SD card slot as this may damage the camera.



**Errors can only be fixed by reformatting the Micro SD on your PC using the formatting tool from <http://www.sdcard.org/consumers/formatter>.**

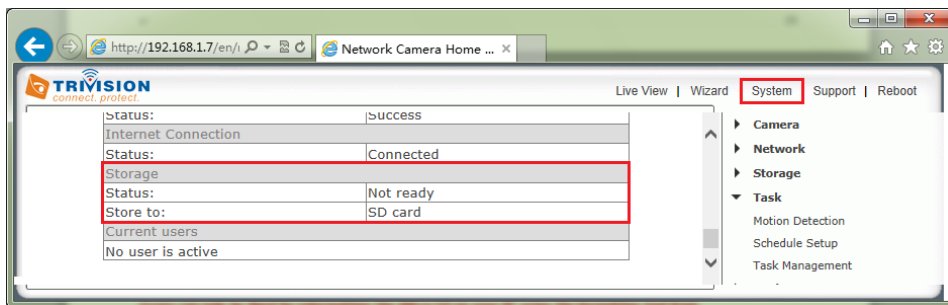

A reboot is normally necessary when you insert a microSD card into the camera and after formatting the microSD card with the camera's format tool.

To access the Micro SD card slot on the outdoor camera, please bring the camera indoor (in an area of low humidity), then unscrew the entire front part of the camera. It is easiest to do it if you take the sunshield off first. The Micro SD card slot is right under the reset button show below

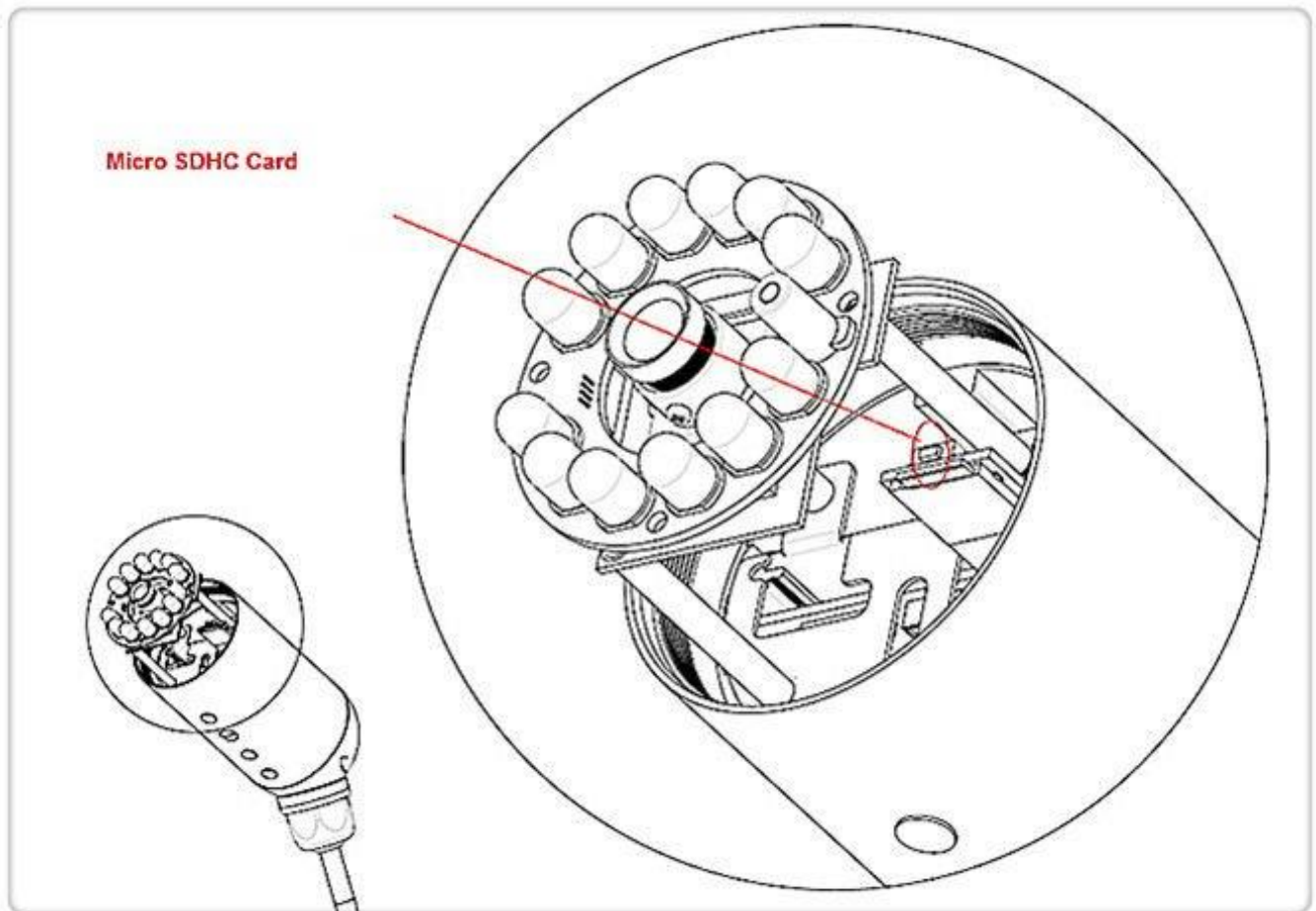
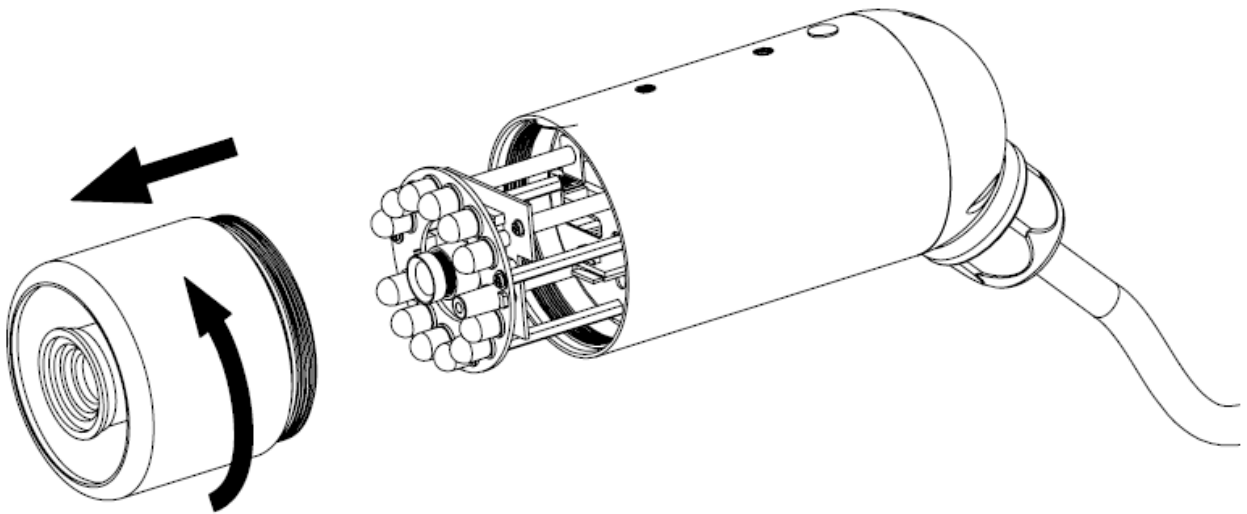

Please be very careful not to touch the lens. The Micro SD slides into the slot and there is a positive “click” when it is locked in place. If it doesn’t want to go in effortlessly it is probably upside down.

When done, please be careful when screwing the front part back on to make sure the threads are engaging nicely. Do not use any tools, hand tight is good enough.

## 6.7.4 NAS STORAGE SETUP

### Storage Setup

Storage:	<input checked="" type="radio"/> Enable <input type="radio"/> Disable
Store to:	<input checked="" type="radio"/> NAS <input type="radio"/> SD card
NAS remote path:	<input type="text" value="//192.168.168.50/ipcam_files"/> (Example: //192.168.168.50/ipcam_files)
Authorization:	<input checked="" type="radio"/> Yes <input type="radio"/> No
User name:	<input type="text" value="admin"/>
Password:	<input type="password" value="•••••"/>
Re-type password:	<input type="password" value="•••••"/>
Store directory:	<input type="text" value="IPCAMERA"/>
Max Space:	<input type="text" value="Unlimited"/>
Max files:	<input type="text" value="5000"/>

**[NAS remote path]** This is the address & path where to save the files on NAS Drive (up to a maximum of 2 directory levels).

**[Authorization1]** Select whether authentication is required by the NAS Drive.

**[User name] & [Password]** Type the user name and password of the NAS Drive. This field is required if your NAS Drive requires authentication.

Click **Apply** to confirm your setting.

**Please note :** After the setting on “Storage” and Micro-SD card or NAS status is ready. You can go to next chapter “Task”, and configure motion detection to initiate the snapshots or video recording to Micro SD card or NAS.

## 6.7.5 Browse Storage

Clicking on Browse Storage will take you to the following screen where you can view or download the contents of the storage drive.

The resulting video files can be viewed with the free QuickTime for Windows or Mac. You do not need QuickTime X or Pro unless you want to compress the resulting video to iPhone/iPod format. Shorter video clips will download much faster. If you have many video files you could also remove the Micro SD card and access it directly from your computer (with suitable adapter if needed). This is only practical for indoor cameras due to easy accessibility of the Micro SD card slot at the bottom.

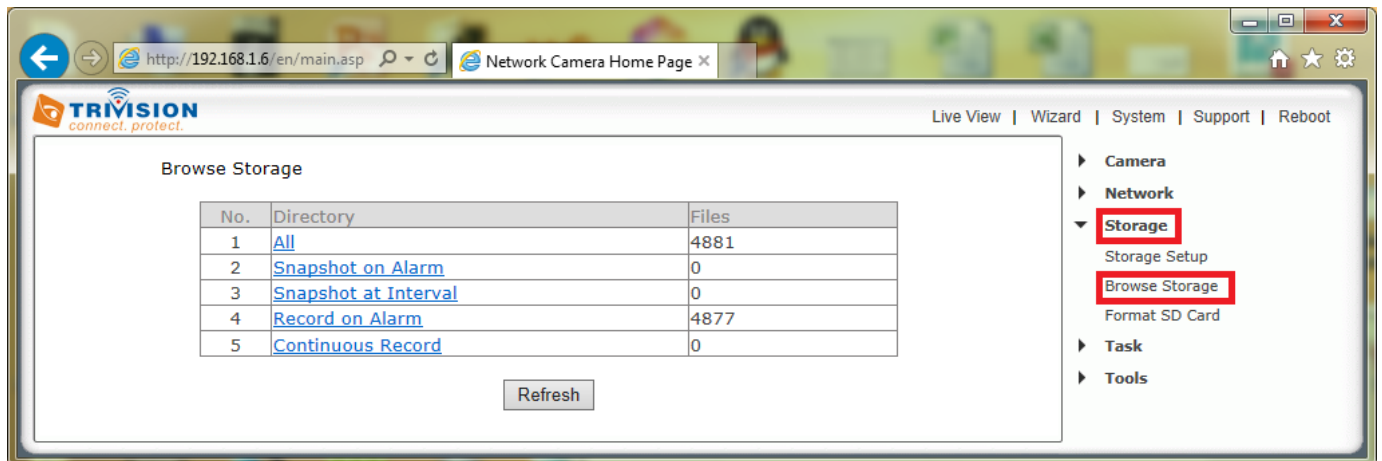

**[All]** Enables you to view and delete all the files recorded.

**[Snapshot on Alarm]** Enables you to view and delete snapshots which were recorded upon motion detection

**[Snapshot at Interval]** Enables you to view and delete all the snapshots which were recorded on periodical basis

**[Record on Alarm]** Enable you to view and delete all the videos which were recorded upon motion detection

**[Continuous Record]** Enables you to view and delete all the videos recorded according to the continuous record schedule.

The browse storage page shows a summary of all the files saved for a specific function. To access the files please click on the relevant link and this will display all the files.

### Snapshot on Alarm

<input type="checkbox"/>	File name	Size (Bytes)	
<input type="checkbox"/>	PA_2013-01-11_12-20-10_379.jpg	49313	<a href="#">download</a>
<input type="checkbox"/>	PA_2013-01-11_12-20-21_813.jpg	49273	<a href="#">download</a>
<input type="checkbox"/>	PA_2013-01-11_12-20-23_002.jpg	49015	<a href="#">download</a>
<input type="checkbox"/>	PA_2013-01-11_12-20-24_982.jpg	49166	<a href="#">download</a>
<input type="checkbox"/>	PA_2013-01-11_12-20-26_962.jpg	49042	<a href="#">download</a>
<input type="checkbox"/>	PA_2013-01-11_12-20-30_158.jpg	48893	<a href="#">download</a>
<input type="checkbox"/>	PA_2013-01-11_12-20-31_352.jpg	48941	<a href="#">download</a>
<input type="checkbox"/>	PA_2013-01-11_12-20-36_752.jpg	47746	<a href="#">download</a>

## 6.7.6 Format SD Card

To format SD card, all files will be lost after format.

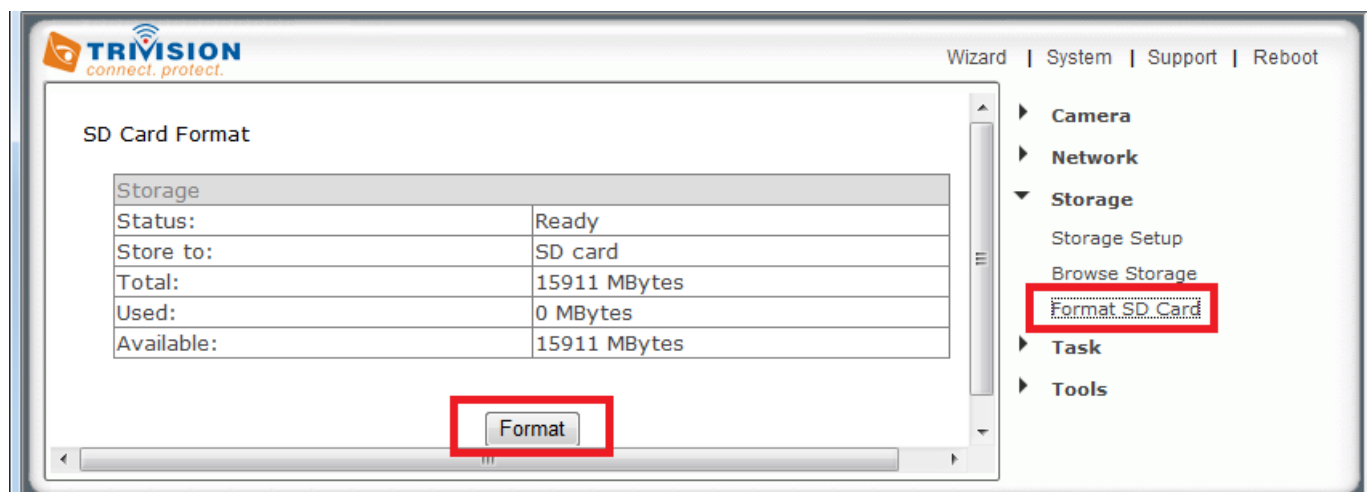

### SD Card Format

Storage	
Status:	Not ready
Store to:	SD card

Format

Logon to the camera, under Settings>Storage>Format SD card

Note: Before the SD card is formatted the Format SD card page will display status as "Not Ready". The SD card format can take a few minutes depending on the size of the SD card.

**A reboot is normally necessary when you insert a microSD card into the camera and after formatting the microSD card with the camera's format tool.**



## 6.8 TASK

### 6.8.1 Motion Detection Using Internet Explorer

Motion Detection can trigger an alarm that sends images via e-mail or FTP (File Transfer Protocol). You can set up to four different Motion Detection windows.

The camera refers to motion detection as an “alarm”. You can select what you want the camera to do once the motion is detected. In general, motion detection works by comparing the current video frame with the averages of the previous video frames. Any difference is considered to be motion, and the sensitivity adjustment can be used to make the camera more aware or less aware of small amounts of motion.

*Moving an object (a person or a car, for instance) directly toward the camera may not trigger motion detection until the object is within 10 to 15 feet of the camera. Motion detection seems to work well when the object is moving from one side of the picture to the other side, often triggering in a second or less.*

The factory default setting for motion detection is a single motion detection window covering the entire visible area. The “Motion Detection” menu allows you to designate up to 4 separate windows with individually adjustable sensitivity. After selecting “Motion detection” from the main settings screen, you may need to expand the size of the display window towards the right to see the 4 controls for individual motion detection windows. Each window can have individually adjustable sensitivity and threshold.

Please note that this “Motion Detection” menu is entirely optional and is generally not used unless you have very specific requirements to treat motion on some parts of the screen different from other parts.

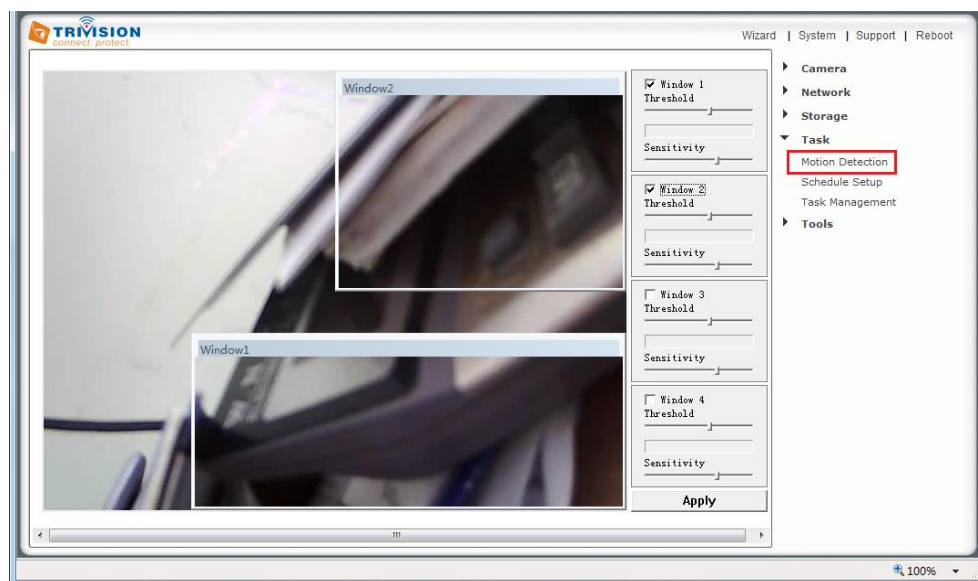

**[Window]** Check this box to enable the window.

**[Threshold]** Determines at what point the alarm is triggered. A lower threshold means less motion is needed to trigger the alarm. A higher threshold means more motion is needed to trigger the alarm. Threshold is indicated by the blue bar when motion is detected.

**[Sensitivity]** Determines how easily the camera detects motion. Lower sensitivity means the camera is less likely to detect motion. Higher sensitivity means the camera is more likely to detect motion.

*Note: Sliding the Sensitivity bar to the left will decrease the sensitivity of the motion detection i.e. ‘More’ movement is required to trigger the alarm.*

*Internet Explorer can show you a live indicator for motion: When there is motion, a blue level appears between the sensitivity and threshold slider as shown in the picture. More blue means more motion. To trigger an alarm (and hence send out emails or upload to an FTP server etc) the detected amount of motion needs to be larger than the threshold setting. If the blue level does not reach the threshold setting the motion is ignored.*

*The best way to configure these settings is to adjust the settings and have someone walk in front of the camera*

**until your feel you are getting the required results. This trial and error method make take quite long to get right but it's the best way to obtain good results.**

**Please note:** Motion detection in Internet Explorer uses the ActiveX plug-in. You will need to install or enable this plug-in if you do not have it. To check you have ActiveX enabled visit <http://www.pcpitstop.com/testax.asp>

To reduce the chance of false alarms you would increase the threshold (move threshold slider to right) or decrease sensitivity (move sensitivity slider to left) .

## 6.8.2 Motion Detection using other browsers(Firefox, Chrome, Safari)



**[Window]** Check this box to enable the window.

**[Threshold]** Determines at what point the alarm is triggered. A lower threshold means less motion is needed to trigger the alarm. A higher threshold means more motion is needed to trigger the alarm. Threshold is indicated by the blue bar when motion is detected.

**[Sensitivity]** Determines how easily the camera detects motion. Lower sensitivity means the camera is less likely to detect motion. Higher sensitivity means the camera is more likely to detect motion.

To reduce the chance of false alarms you would increase the threshold (move threshold slider to right) or decrease sensitivity (move sensitivity slider to left) .

**Please note:** Motion detection in other browsers uses the Adobe Flash plug-in. You will need to install the Flash plug-in if you do not have it. To check you have the latest version of Flash, visit <http://updateflash.org>

## 6.8.3 Schedule Setup

The alarm that the motion detection triggers can be set to be active or inactive at certain times of the week. By default, the schedule is set to be “active” at all times “always”.

However you can set the schedule not to trigger alarms at certain times (useful for instance if you don’t want alarms to go off while your office is open from 9am until 5.30pm). You can set up to 4 schedules, and you can use these to send alarms to different places – such as emails, FTP or SD card.

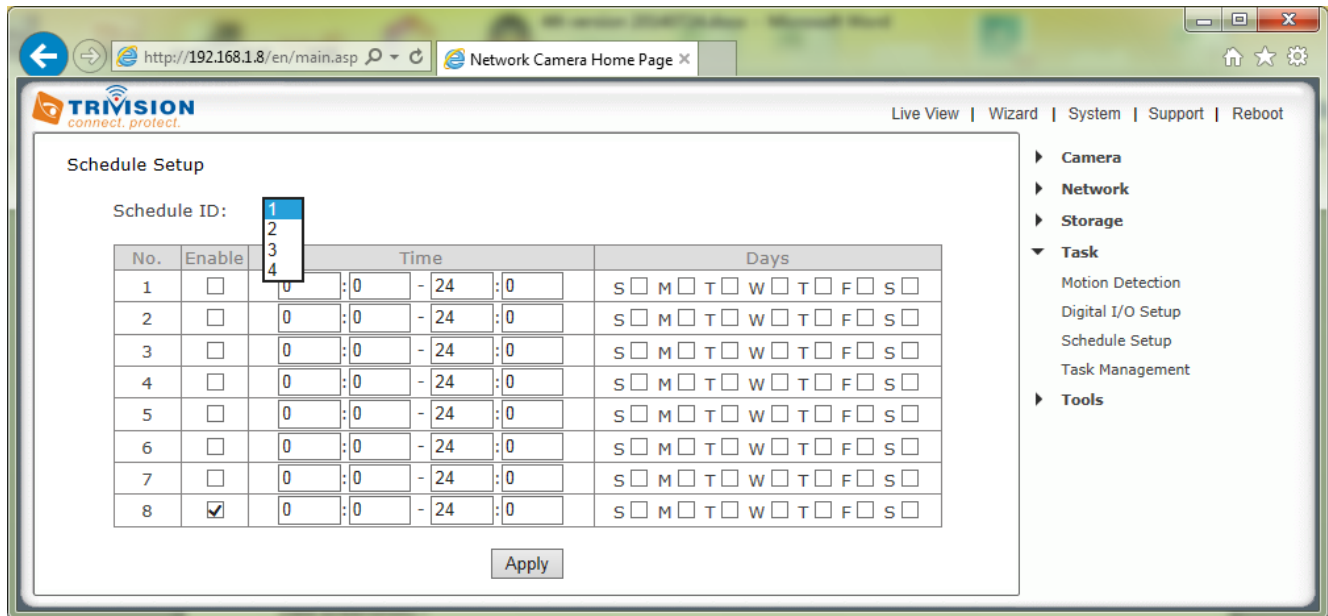

### Schedule Setup Options

**[Schedule ID]** Select the ID, you can save up to 4 schedules and use them for different purposes.

**[No.]** Setup the specified times in every Schedule ID, you can save up to 8 specified times and use them for different purposes.

**[Enable]** Activates the alarm on specified times. Ticking this box to activate the alarm on the specified times.

**[Start time]** Start time of the alarm.

**[End time]** End time of the alarm.

**[Days]** Ticking this box activate the alarm daily on the specified times from Monday to Sunday.

Click **Apply** to confirm your setting

## 6.8.4 Task Management

There are various tasks you can enable on your camera. This section will explain the various tasks and their functions

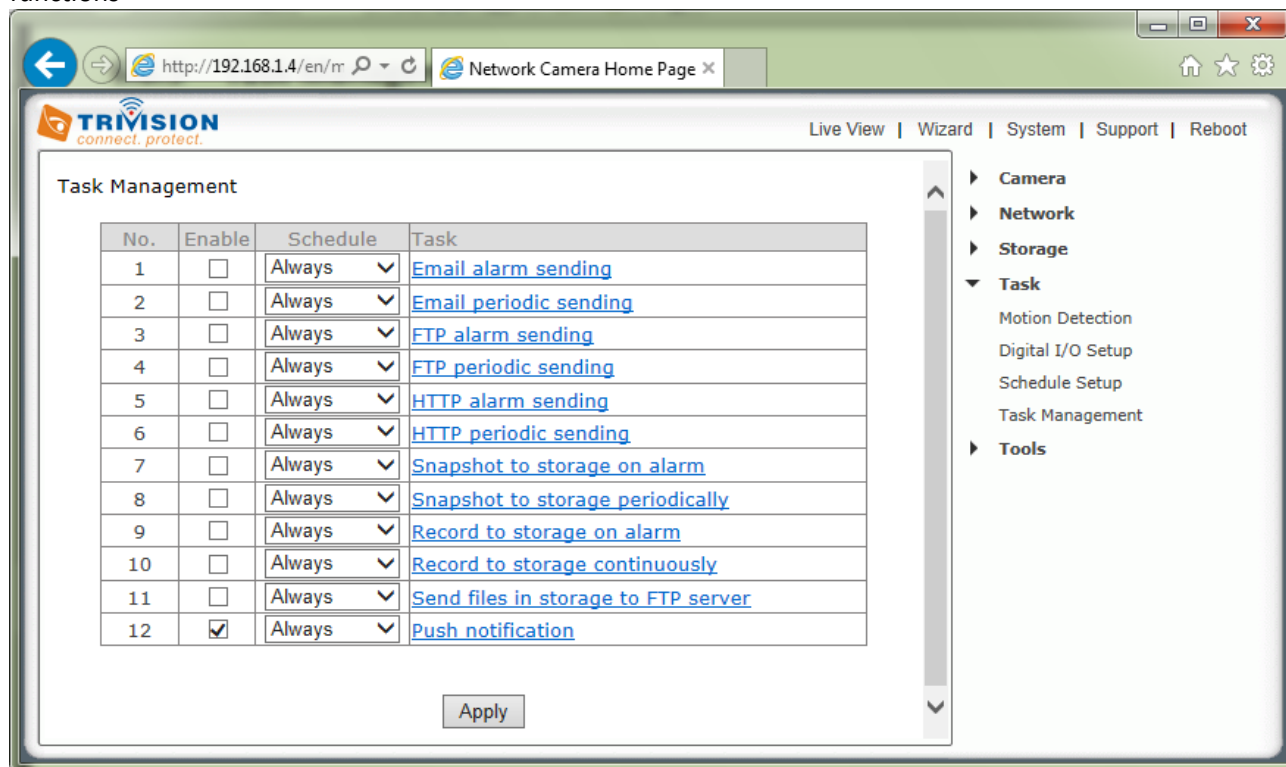

No.	Enable	Schedule	Task
1	<input type="checkbox"/>	Always	<a href="#">Email alarm sending</a>
2	<input type="checkbox"/>	Always	<a href="#">Email periodic sending</a>
3	<input type="checkbox"/>	Always	<a href="#">FTP alarm sending</a>
4	<input type="checkbox"/>	Always	<a href="#">FTP periodic sending</a>
5	<input type="checkbox"/>	Always	<a href="#">HTTP alarm sending</a>
6	<input type="checkbox"/>	Always	<a href="#">HTTP periodic sending</a>
7	<input type="checkbox"/>	Always	<a href="#">Snapshot to storage on alarm</a>
8	<input type="checkbox"/>	Always	<a href="#">Snapshot to storage periodically</a>
9	<input type="checkbox"/>	Always	<a href="#">Record to storage on alarm</a>
10	<input type="checkbox"/>	Always	<a href="#">Record to storage continuously</a>
11	<input type="checkbox"/>	Always	<a href="#">Send files in storage to FTP server</a>
12	<input checked="" type="checkbox"/>	Always	<a href="#">Push notification</a>

**[Enable]** Enable task.

**[Schedule]** Option to choose always or set a particular schedule. Check Schedule setup to select the right schedule ID for your task.

**[Task]** Task function. Click on the task to login the task setting screen below.

Click **Apply** to confirm your setting

## 6.8.4.1 Email Alarm Sending/Email Periodic Sending

For automatic emailing you will need both an outgoing email server and one or more email receiving addresses. If you don't have this information handy you may want to refer to your internet service provider's help pages or your Microsoft Outlook or other email program account settings.

Following is an example of a proper configuration for using Gmail as the outbound server, which then can send email to any receiving email address.

The image shows two screenshots of the TRIVISION web interface. The top screenshot displays the 'Task Management' section with a table of tasks. The bottom screenshot shows the 'Email Alarm Sending' configuration page.

**Task Management Table:**

No.	Enable	Schedule	Task
1	<input checked="" type="checkbox"/>	Always	Email alarm sending
2	<input type="checkbox"/>	Always	Email periodic sending
3	<input type="checkbox"/>	Always	FTP alarm sending
4	<input type="checkbox"/>	Always	FTP periodic sending
5	<input type="checkbox"/>	Always	HTTP alarm sending
6	<input type="checkbox"/>	Always	HTTP periodic sending
7	<input type="checkbox"/>	Always	Snapshot to storage on alarm
8	<input type="checkbox"/>	Always	Snapshot to storage periodically
9	<input checked="" type="checkbox"/>	Always	Record to storage on alarm
10	<input type="checkbox"/>	Always	Record to storage continuously
11	<input type="checkbox"/>	Always	Send files in storage to FTP server
12	<input type="checkbox"/>	Always	Push notification

**Email Alarm Sending Configuration:**

- Snapshot from: Primary stream
- Snapshot duration: 1 seconds (1-20)
- Snapshot frame rate: 1 fps
- Alarm interval: 0 seconds (0-86400 0:continuous)
- Image file name: PA
- Suffix of file name:  Sequence number  Date time  None
- SMTP server name: smtp.gmail.com
- SMTP server port: 465
- Secure SSL connection:  Yes  No
- Authentication:  Yes  No
- User name: livedemo@gmail.com
- Password: [Redacted]
- Re-type password: [Redacted]
- Sender mail address: livedemo@gmail.com
- Receiver mail address: livedemo@gmail.com, live@gmail.com
- Subject: Warning from Network Camera
- Message: [Empty]

**Note:** Gmail requires that you go to your account settings on Gmail.com and enable the POP feature (Post Office Protocol). If your Gmail account does not have POP enabled, the camera will not be able to send email.

**[Enable]** Enable task.

**[Schedule]** Option to choose always or set a particular schedule. Check Schedule setup to select the right schedule ID for your task.

**[Task]** Task function. **Click on the task to login the task setting screen below.**

Click **Apply** to confirm your setting

1. **Snapshot from**--- Select snapshot stream source which can be “Primary stream” , “Secondary stream” and “ Mobile Stream” . For smaller pictures you can select from “Secondary stream”.
2. **Snapshot Duration**-- The number of seconds that the camera should keep sending emails with attached image after motion stops.
3. **Snapshot Frame Rate**-- The number of frames per seconds that the camera should keep sending images at when an alarm is triggered. If “Snapshot duration” had a value of 4 and “snapshot frame rate” had a value of 2, you would be getting 2 images each second for 4 seconds in a row, meaning 8 pictures total for each motion detection event.
4. **Alarm Interval**-- This is the number of seconds for which the camera should stop sending e-mail alerts after the first set. Setting the time to 0 disables this feature. It allows you to designate a time (in seconds) during which new emails are suppressed. For example, if you want to avoid a flood of emails, you could set this time to 3600 seconds so that after a motion detection event you wouldn't get any new emails for at least 1 hour.
5. **SMTP server name**--Type the name or IP address of the SMTP server you want to use for sending the e-Mails. Please note that some networks do not allow e-mail relaying. Check with your system administrator or Internet service provider for more details.
6. **SMTP server port**-- The port number of the e-mail server (default is 25)
7. **Secure SSL connection**--Select whether your SMPT server requires an SSL connection.
8. **Authentication**--Select whether authentication is required by the SMTP server.
9. **User name] & Password**--Type the user name and password of the e-mail account you wish to use. This field is required if your SMTP server requires authentication.
10. **Re-type password**-- Re-type the password.
11. **Sender e-mail address**--Type the e-mail address of the account you are using to send the e-mail. This will be the address the emails come from.
12. **Receiver e-mail address**--Type the recipients' e-mail addresses for who you want the emails to be sent to. Up to 3 addresses can be entered.
13. **Subject**--Subject of the e-mail that is sent. Entering a relevant subject will help identify the alarm better. i.e. “Garage Alarm”
14. **Message**--Type the text you wish to appear in the e-mail. E.g. this is to notify you that your alarm has been triggered.

**Notes:** Email settings can be obtained from your e-mail service provider. An SMTP email account is required – these are very common if you use POP3 email and some IMAP servers. A true IMAP server will not work. Some ISPs won't let you use any other SMTP server other than their own (British Telecom BT is a good example of this).

15. Click **Apply** to confirm your setting.

16. Note that if you have a typo in any of this information, the camera would have no way to let you know about that.

You just won't get emails. To summarize, Gmail requires:

- SMTP server name: **smtp.gmail.com**
- Port: **465**
- Authentication: **Yes**
- Secure SSL connection: **Yes**
- Username must include: **@gmail.com**
- Other mail servers have their own unique settings and requirements. Some web mail services such as Yahoo can typically not be used for sending unless you subscribe to optional paid subscriptions like Yahoo PLUS.
- **Receiver mail address:** Any email account can be used as a receiving email address, including the same as sending email. You can also send email to several receiving email addresses, up to 3 total.

17. NOTE: It is easy to have a typo. The SMTP server name never has an @symbol. On the other hand, email addresses must have an @ symbol.



## 6.8.4.2 Email Periodic Sending

Instead of using motion detection in Email Alarm Sending, you can also use the “Email Periodic sending” menu to upload pictures at regular time intervals.

“Email Periodic Sending” menu is very similar to setting up the “Email Alarm Sending”, so it’s not explained here.

The screenshot shows the Trivision web interface for configuring Email Periodic Sending. The interface includes a navigation menu on the right with options like Camera, Network, Storage, Task, and Tools. The 'Task' menu is expanded, and 'Task Management' is highlighted. The main configuration area is titled 'Email Periodic Sending' and contains the following fields:

- Period interval:** 0 H 60 M 0 S (MAX: 24 hours)
- Snapshot from:** Primary stream
- Snapshot duration:** 1 seconds (1-20)
- Snapshot frame rate:** 1 fps
- SMTP server name:** smtp.gmail.com
- SMTP server port:** 465
- Secure SSL connection:** Yes (selected)
- Authentication:** Yes (selected)
- User name:** livedemo@gmail.com
- Password:** [masked]
- Re-type password:** [masked]
- Sender mail address:** livedemo@gmail.com
- Receiver mail address:** livedemo@gmail.com, info@trivisiontech.com
- Subject:** Warning from Network Camera
- Message:** [empty]

Buttons for 'Apply' and 'Back' are located at the bottom of the configuration area.

**Period Interval**-- Time interval between snapshots. It allows you to designate a time (in seconds or minutes or hours) during which new emails are suppressed. For example, if you want to avoid a flood of emails, you could set this time to 60 minutes so that you wouldn’t get any new emails for 1 hour.

Some email server settings to use your camera

with popular email providers: **gmail.com**

SMTP server name: smtp.gmail.com

SMTP server port: 465

Secure SSL: Yes

Authentication: Yes

Username: YourUserName@gmail.com

Password: xxxxxxx

**gmx.com**

SMTP server name: smtp.gmx.com

SMTP server port: 587

Secure SSL: No

Authentication: Yes

Username: YourUserName@gmx.net

Password: xxxxxxx

**att.net**

SMTP server name: smtp.att.yahoo.com

SMTP server port: 25

Secure SSL: No

Authentication: Yes

Username: YourUserName@att.net

Password: xxxxxxx

**comcast.net**

SMTP server name: smtp.comcast.com

SMTP server port: 587

Secure SSL: No

Authentication: Yes

Username: YourUserName@comcast.net

Password: xxxxxxx

Please note: The most common reason for Email Alerts not being sent is that the cameras Primary DNS IP Address is not set. You can check this on your camera Settings System page.

If it is empty, you can set it on the TCP/IP settings page, set to your Default Gateway address and this should solve the problem



### 6.8.4.3 FTP Alarm Sending/FTP Periodic Sending

If you prefer, you can have the pictures uploaded to an FTP server instead of an email address. There are many choices for FTP servers.

For example, you could enable the built-in FTP server function on one of your computers or download free FTP server software such as FileZilla server.

Another possibility is to use an online account with FTP access, which is sometimes even available for free with a limited amount of storage. You can download free FTP client software to manage the FTP server, such as FileZilla client. Yet another option for FTP server is to use a standalone NAS (Network Attached storage) hard drive such as the MyBook World Edition.

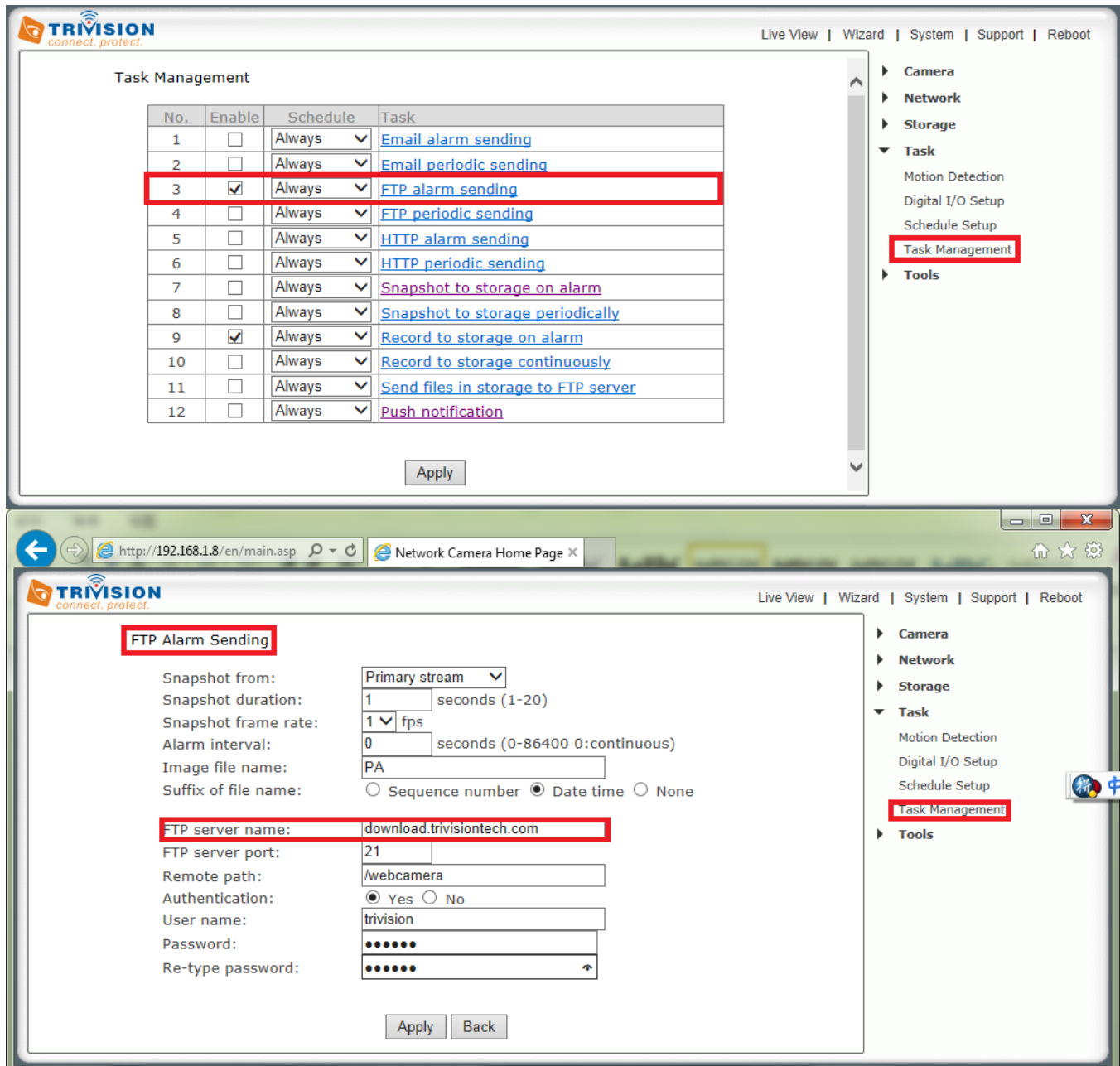

Setup of the **FTP alarm sending** menu is very similar to setting up the **Email alarm Sending/Email periodic sending**, so we don't explain the **Snapshot from, Snapshot duration, Snapshot frame rate, Alarm interval, Image file name, Suffix of file name** again here.

**[Enable]** Enable task.

**[Schedule]** Option to choose always or set a particular schedule. Check Schedule setup to select the right schedule ID for your task.

**[Task]** Task function. **Click on the task to login the task setting screen below.**

Click **Apply** to confirm your setting

**[FTP server name]** Type the name or IP address of the FTP server. At a minimum you need the IP address (FTP server name) for your FTP server. The port is almost always 21, and typical servers need a username and password which means "Authentication" should be set to "Yes".

**[FTP server port]** The port number of the FTP server (default is 21).

**[Remote path]** Input the file directory. It is an optional setting to specify a folder on the FTP server. If you decide to use this feature, you have to make sure that the folder exists on the FTP server with the exact same spelling.

**[Authentication]** Select whether authentication is required by the FTP server. Choose "No" for anonymous access.

**[User name]** Type your FTP user name.

**[Password]** Type your FTP password.

**[Re-type password]** Re-type your password.

Click **Apply** to confirm your settings.

Instead of using motion detection in "FTP alarm sending", you can also use the "FTP Periodic sending" menu to upload pictures at regular time intervals.

**[Period Interval]**--Time interval between snapshots. It allows you to designate a time (in seconds or minutes or hours) during which new emails are suppressed. For example, if you want to avoid a flood of emails, you could set this time to 60 minutes so that you wouldn't get any new emails for 1 hour.

**Note:***The menu option for "HTTP alarm sending" and "HTTP Periodic sending" are not explained here since HTTP servers are only used by network professionals.*

## 6.8.4.4 Snapshot to Storage on Alarm/ Snapshot to Storage Periodically

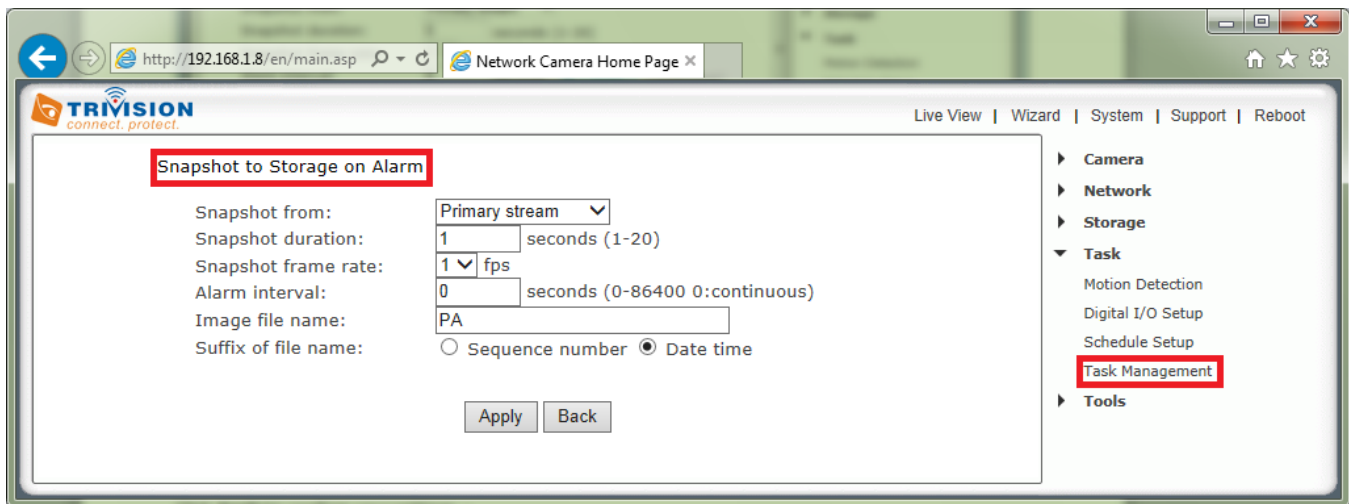

**[Snapshot from]** Select snapshot stream source.

**[Snapshot duration]** The number of seconds that the camera should keep sending images after motion stops.

**[Snapshot frame rate]** The number of frames per seconds that the camera should keep sending images at when an alarm is triggered.

**[Alarm Interval]**--Number of seconds for which the camera should stop sending e-mail alerts after the first set. Setting the time to 0 disables this feature. It allows you to designate a time (in seconds) during which new pictures are suppressed. For example, if you want to avoid a flood of pictures, you could set this time to 3600 seconds so that after a motion detection event you wouldn't get any new pictures for at least 1 hour.

**[Image file name]** Name of file image snap shots are saved to

**[Suffix of file name]** Choose between Sequence number and Date

Click **Apply** to confirm your settings.

Instead of using motion detection (Snapshot to Storage on Alarm), you can also use the "Snapshot to storage periodically" menu to take snapshots at regular time intervals (Snapshot to Storage Periodically)

The "**Period Interval**" allow you to designate a time (in seconds or minutes or hours) during which new snapshots are suppressed. For example, if you want to avoid a flood of snapshots, you could set this time to 60 minutes so that you wouldn't get any new snapshots for 1 hour.

## 6.8.4.5 Record to Storage on Alarm/ Record to Storage Continuously

TRIVISION  
connect. protect.

Live View | Wizard | System | Support | Reboot

**Record to Storage on Alarm**

Record from: Primary stream

Post-recording time: 10 seconds (5-86400)

Split duration: 600 seconds (10-1200)

Record thumbnail:  Enable  Disable

Record file name: MA

Suffix of file name:  Sequence number  Date time  Date time & record time length

Apply Back

Camera  
Network  
Storage  
Task  
Motion Detection  
Digital I/O Setup  
Schedule Setup  
**Task Management**  
Tools

**[Enable]** Enable task.

**[Schedule]** Option to choose always or set a particular schedule. Check Schedule setup to select the right schedule ID for your task.

**[Task]** Task function. **Click on the task to login the task setting screen below.**

Click **Apply** to confirm your setting

1. **[Record from]**-- Select the stream from which it should record. It can be "Primary stream" , "Secondary stream" and " Mobile Stream" . For smaller pictures you can select from "Secondary stream" or "Mobile Stream".
2. **[Post-recording time]**--The number of seconds that the camera should keep recording video after motion stops. If there is any motion within this time the camera will keep recording until there is no motion for the duration of this parameter. It can be from 5 seconds to 24 hours.
3. **[Split duration]**-- This specifies the maximum duration of one file. If the recording goes on for longer than this parameter the camera will split the video into a number of files.
4. **[Record thumbnail]**-- Enable or disable thumbnail.
5. **[Image file name]** --Name of file image snap shots are saved to
6. **[Suffix of file name]**-- Choose between Sequence number and Date
7. Click **Apply** to confirm your settings.

Instead of using motion detection (Record to Storage on Alarm), you can also use the "Record to storage continuously" menu to record video at 24 hours or as per your schedule.

## 6.8.4.6 Send files in storage to FTP server

The screenshot shows a web browser window with the URL <http://192.168.1.8/en/main.asp>. The page title is "Network Camera Home Page". The main content area is titled "Send Files in Storage to FTP Server" and contains the following fields:

- FTP server name: 192.168.1.20
- FTP server port: 21
- Remote path: /ipcam
- Authentication:  Yes  No
- User name: admin
- Password: [masked]
- Re-type password: [masked]

At the bottom of the form are "Apply" and "Back" buttons. On the right side, there is a navigation menu with the following items:

- Camera
- Network
- Storage
- Task
  - Motion Detection
  - Digital I/O Setup
  - Schedule Setup
  - Task Management (highlighted with a red box)
- Tools

**[Enable]** Enable task.

**[Schedule]** Option to choose always or set a particular schedule. Check Schedule setup to select the right schedule ID for your task.

**[Task]** Task function. **Click on the task to login the task setting screen below.**

Click **Apply** to confirm your setting

**[FTP server name]** Type the name or IP address of the FTP server. At a minimum you need the IP address (FTP server name) for your FTP server. The port is almost always 21, and typical servers need a username and password which means "Authentication" should be set to "Yes".

**[FTP server port]** The port number of the FTP server (default is 21).

**[Remote path]** Input the file directory. It is an optional setting to specify a folder on the FTP server. If you decide to use this feature, you have to make sure that the folder exists on the FTP server with the exact same spelling.

**[Authentication]** Select whether authentication is required by the FTP server. Choose "No" for anonymous access.

**[User name]** Type your FTP user name.

**[Password]** Type your FTP password.

**[Re-type password]** Re-type your password.

Click **Apply** to confirm your settings

**Note:** *Once successfully transferred, each original file on the Micro SD card is deleted.*

## 6.8.4.7 Push Notification

TRIVISION  
connect. protect.

Live View | Wizard | System | Support | Reboot

iOS Push Notification

Post time:  seconds (5-86400)  
Alarm interval:  seconds (5-86400)

- ▶ Camera
- ▶ Network
- ▶ Storage
- ▼ Task
  - Motion Detection
  - Digital I/O Setup
  - Schedule Setup
  - Task Management
- ▶ Tools

**[Enable]** Enable task.

**[Schedule]** Option to choose always or set a particular schedule. Check Schedule setup to select the right schedule ID for your task.

**[Task]** Task function. Click on the task to login the task setting screen below.

Click **Apply** to confirm your setting

**[Post time]**--The number of seconds that the camera should keep alarm message sending after motion stops. If there is any motion within this time the camera will keep sending alarms until there is no motion for the duration of this parameter. It can be from 5 seconds to 24 hours.

**[Alarm Interval]**--Number of seconds for which the camera should stop sending alerts after the first set. Setting the time to 0 disables this feature. It allows you to designate a time (in seconds) during which new alerts are suppressed. For example, if you want to avoid a flood of alerts, you could set this time to 3600 seconds so that after a motion detection event you wouldn't get any new alerts for at least 1 hour.



## 6.9 Tools Menu

The Tools menu is located on the right of the Settings screen. When you click on the word “Tools”, a sub-menu of setup options will be displayed.

### 6.9.1 System Identity

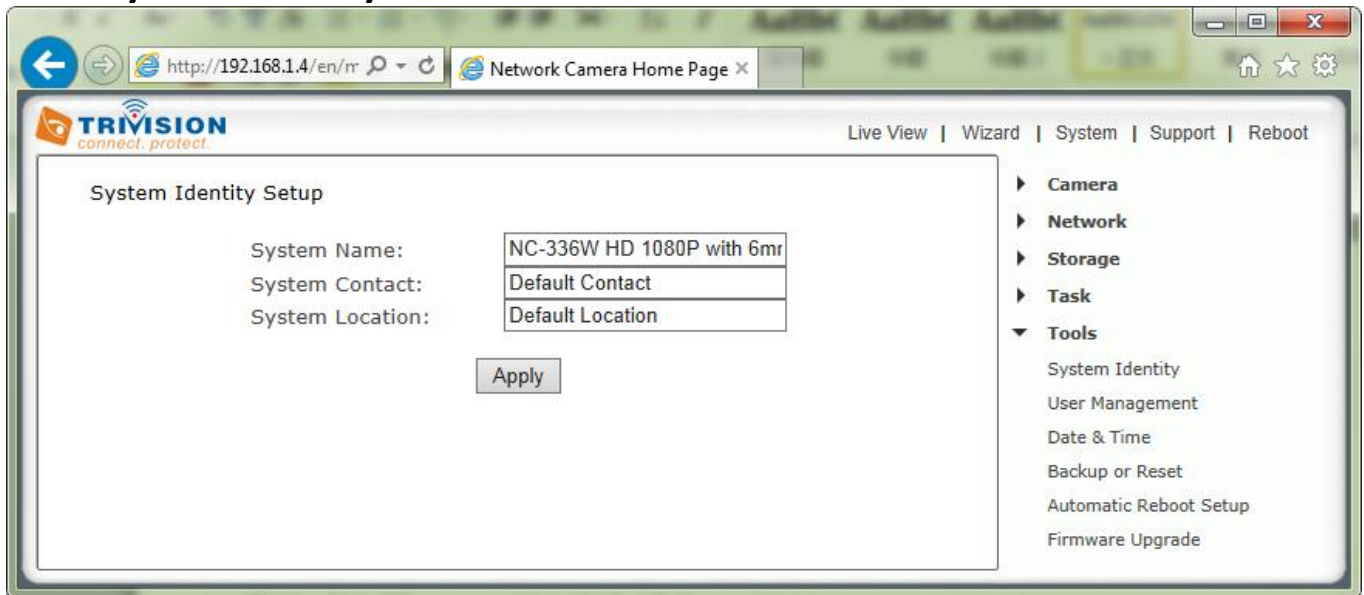

The screenshot shows a web browser window with the URL <http://192.168.1.4/en/m>. The page title is "Network Camera Home Page". The main content area is titled "System Identity Setup" and contains the following fields:

System Name:	NC-336W HD 1080P with 6mr
System Contact:	Default Contact
System Location:	Default Location

Below the fields is an "Apply" button.

The right sidebar menu includes the following items:

- ▶ Camera
- ▶ Network
- ▶ Storage
- ▶ Task
- ▼ Tools
  - System Identity
  - User Management
  - Date & Time
  - Backup or Reset
  - Automatic Reboot Setup
  - Firmware Upgrade

**[System Name]** Type a name to easily identify the camera.

**[System Contact]** Type the contact name of the administrator of the camera. This is useful in large organizations.

**[System Location]** Type the location of the camera. This is useful when using a multi-camera viewer program.

*Tip: The information you fill in can be displayed on the camera. It can help to distinguish different cameras on the network.*

## 6.9.2 User Management

Allows you to add or remove users who can view your camera. Useful if you want to allow others to view your camera, without having full admin rights.

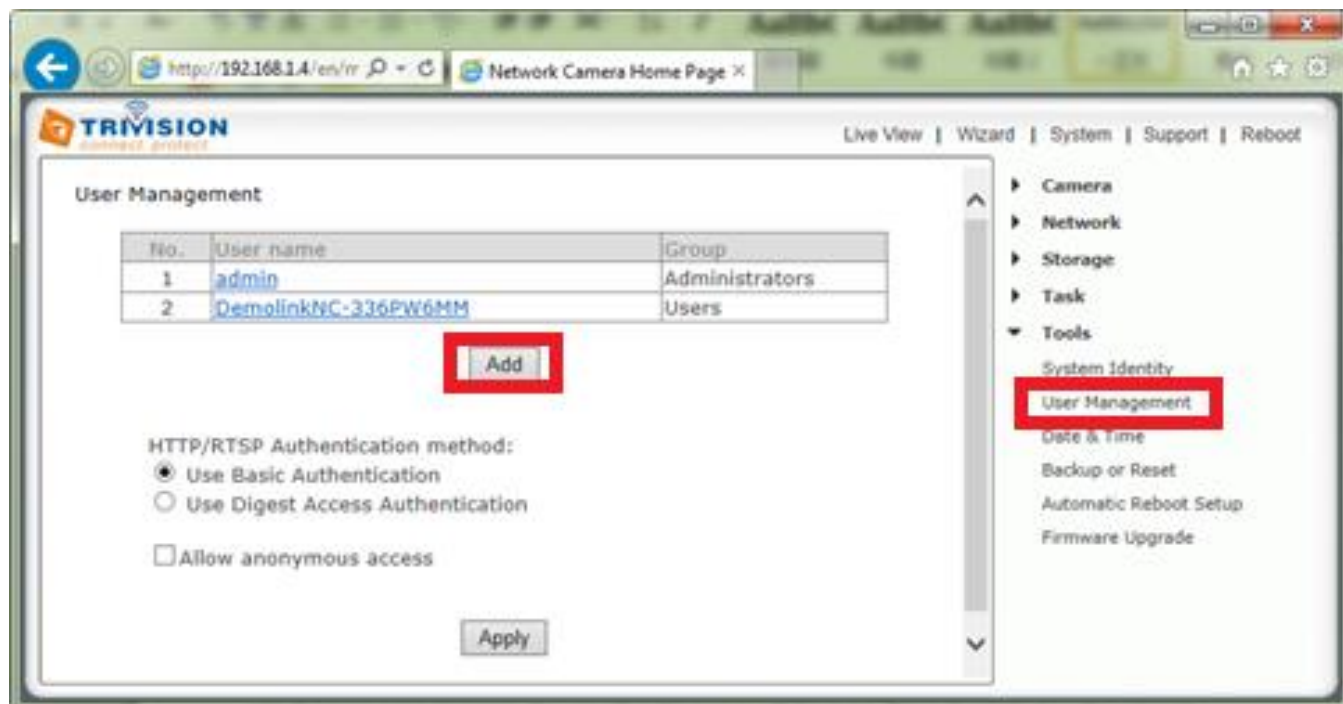

**[Add]** Up to 64 users (including the admin) can be created.

**Adding users:** Click Add on the Camera User List page, then fill in a username and password (twice) and then click Add.

**To edit a user's password:** Click on the user name then enter the new password for that user twice and click Save.

**To delete a user:** Click on the user name then click **Delete**.

**Note:** A maximum of 16 users are allowed to access the camera simultaneously. As the number of simultaneous users increases, the overall performance will decrease. This is dependent on the network bandwidth, not the camera.

**[Allow anonymous access]** This is to be used if you wish to share video with other users, without prompting them for a user name and password. This will allow the user free access to view the "Live View" page, whereas access to the Settings page will still be prohibited.

**[Authentication method]** The "basic" authentication scheme is based on the model that the client must authenticate itself with a user-ID and a password. Digest Access is a more secure login method as the username and password are encrypted before being sent over the internet, however not all systems support Digest Access Authentication.

## 6.9.3 Date & Time

Allows you to set the date and time - used for the timestamp of any files created by the camera

The screenshot shows the TRIVISION web interface for configuring the camera's date and time. The browser address bar shows the URL `http://192.168.1.4/en/m`. The page title is "Network Camera Home Page". The interface includes a navigation menu with options: Live View, Wizard, System, Support, and Reboot. The main content area is titled "Date & Time" and contains the following settings:

- Current device time: `07/24/2014 11:51:10`
- Proposed device time: `07/24/2014 11:51:09`
- Select to change the time zone for the device location: `(UTC-05:00) Eastern Time (US and Canada)`
- Automatically adjust clock for Daylight Saving Time
- Date and time format:  yy/mm/dd hh:mm:ss,  mm/dd/yy hh:mm:ss,  dd/mm/yy hh:mm:ss
- Auto time setting (SNTP):  Enable,  Disable
- Time server: `time.nist.gov`  
e.g. `time.nist.gov`; `ns.arc.nasa.gov`

An "Apply" button is located at the bottom of the configuration area.

**[Current device time]** Internal time of the camera.

**[Proposed device time]** PC system time. On clicking Apply the internal time of the camera will be changed to this time.

**[Select to change the time zone for the device location]** Choose your time zone.

**[Daylight saving time]** tick the box to enable daylight saving time.

**[Date and Time format]** Select the format of the date and time.

**[Auto time setting (SNTP)]** Enable or disable the auto time setting to update to the server below.

**[Time server]** Type the SNTP server name. There are suggestions included.

Note:

1. If the SNTP server is not found the camera's time will be synchronized with the PC time.
2. The camera keeps track of the time even when power is disconnected.

Click **Apply** to confirm your settings.

## 6.9.4 Backup and Reset

Allows you to reset the camera to factory defaults, backup the configuration in case of accidental reset and restore settings from a backup.

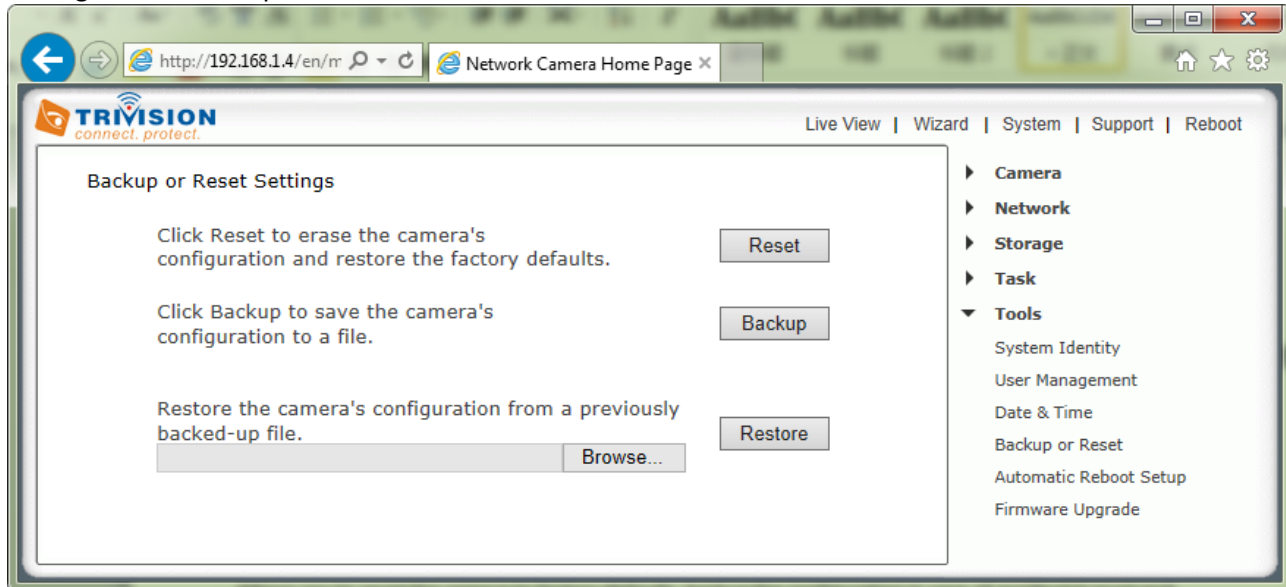

**[Reset]** Click Reset to initialize the camera to default factory settings. All users and settings will be lost, requiring you to reconfigure the camera.

**[Backup]** Click Backup to back-up the current configuration of the camera for future reference. Once you have your camera setup as you require, this is recommended.

To restore a backup file:

**[Browse...]** Click Browse... to search for a backup configuration you wish to upload to the camera, then click **Restore**.

Note: Do not turn off the power during the Restore function since this might corrupt the camera's firmware

## 6.9.5 Automatic Reboot Setup

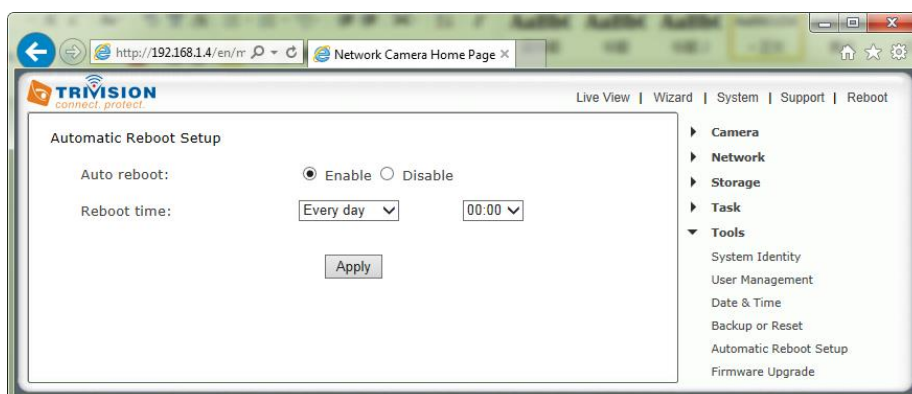

**[Auto reboot]** Enable task to keep camera automatic self-checking the connectivity status.

**[Reboot Time]** Option to choose always or set a particular schedule.

## 6.9.6 Firmware Upgrade

From time to time a new firmware may be released for your model of camera. To check for updates, consult with our technical support before firmware upgrade.

Once you have downloaded the latest firmware, store it in a place that is easily to get to. The firmware is in a ZIP file, which is a compressed file format. You will need to move or copy the file from this compressed folder (some versions of Windows will allow you to do this, but if not, you will need a program like WinZip or WinRAR to unzip the file to a standard folder). This is very important as the firmware will not update properly if it's left in the compressed state.

### TIPS

- We do recommend you update to the latest firmware for your camera whenever we release one to take advantage of new features and bug fixes. However, this is a serious process and can damage your camera if not done correctly.
  - If your firmware is several versions out of date, upgrading straight to the latest one is perfectly fine, you do not need to install each and every update.
  - It is recommended you reboot your computer before attempting this operation and then close ALL programs that may interfere with the process. Interruption to this process will result in your camera being un-useable.
  - You may want to backup your settings before the upgrade. You may also want to make a note of your settings before upgrade. The backup/restore configuration may not work between firmware upgrades, so always make a note before starting.
- Click "Tool", then click "Firmware ", and you'll get to this screen :

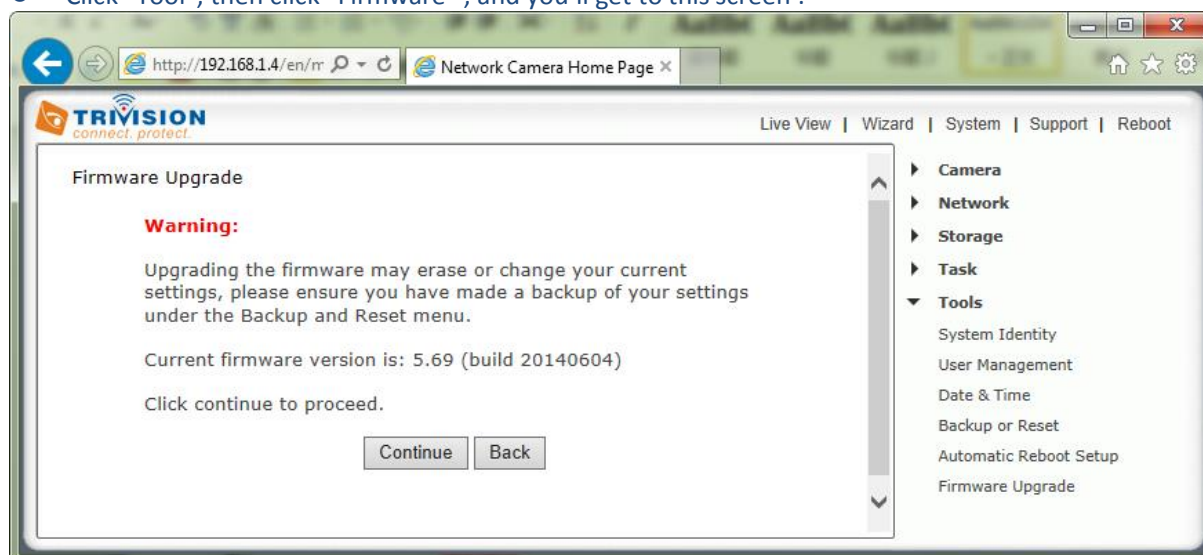

- Click " Continue" , then you will get to this screen. Select Browse... and locate the file you have uncompressed from the ZIP file.  
Please note: Once you have located the file and selected it, click Upgrade.  
When you click upgrade, the process will start. This can take 5 - 10 minutes. Don't perform any other actions on your computer while you are doing this upgrade.

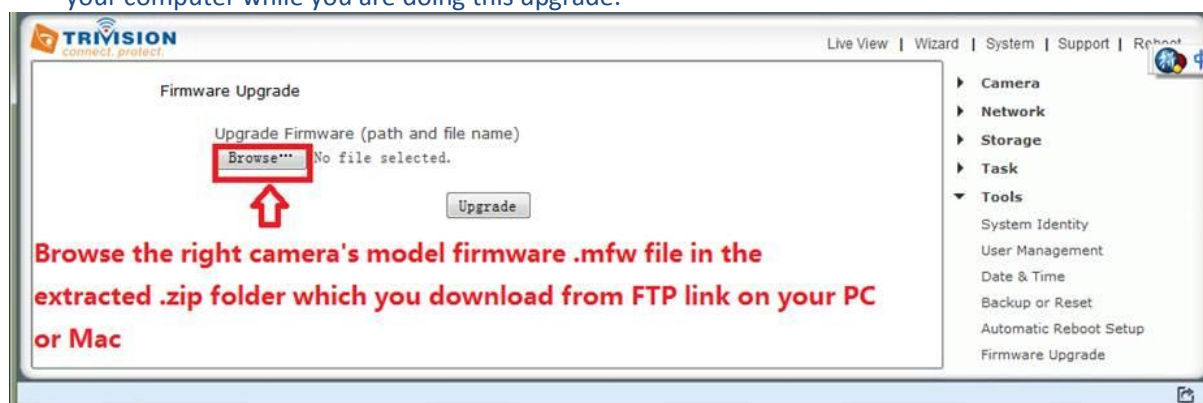

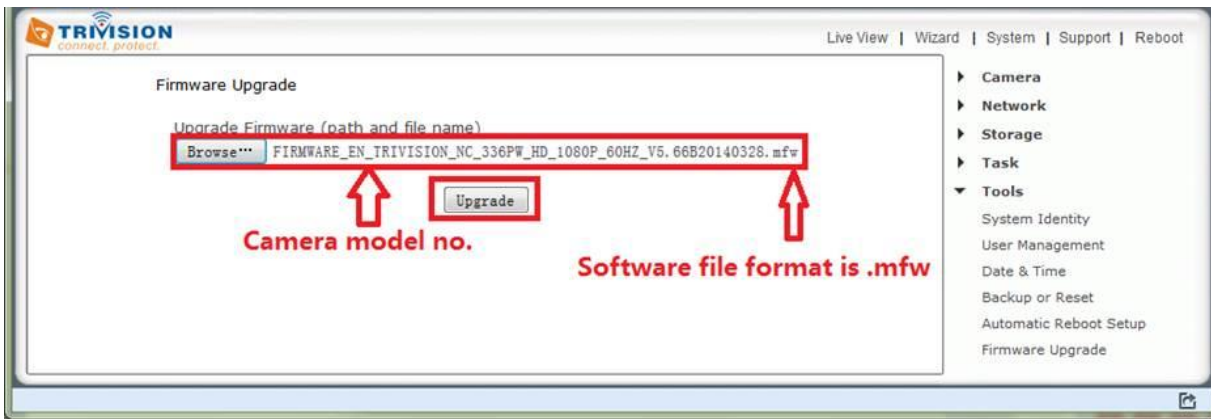

- Wait 3-5 minute till the warning message “Caution ! Upgrading Firmware! Please don’t turn off power or reset the camera till firmware upgrade successfully” displayed.

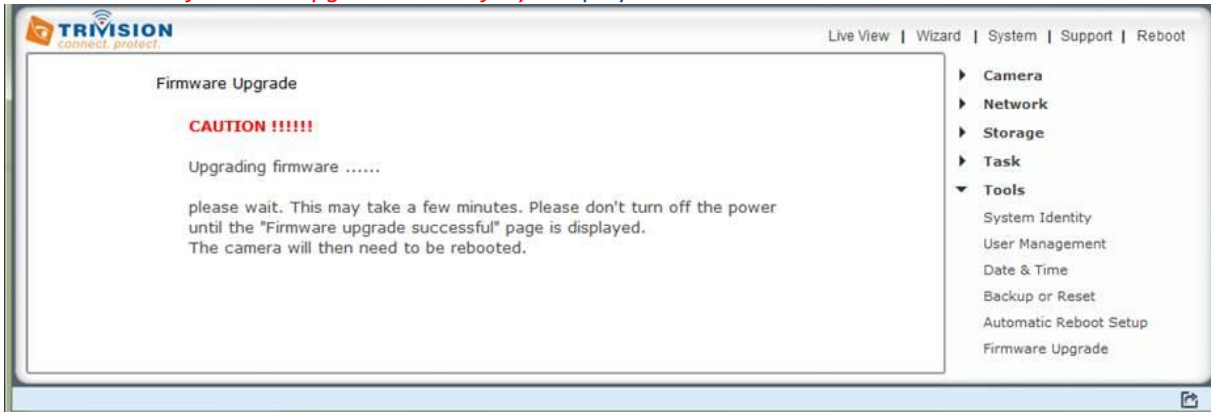

- Till warning message above displayed, then Wait 2-3 minutes again till the message. After the upgrade completes, you will be prompted “Firmware upgrade successfully, reboot now ?” to reboot the camera, then click “reboot”, after this your latest firmware will be recorded.



You can check the camera firmware version in camera “system”, which is on the top of the right corner .you will get to the screen . If your firmware upgrade succeed, then the firmware version will be updated.

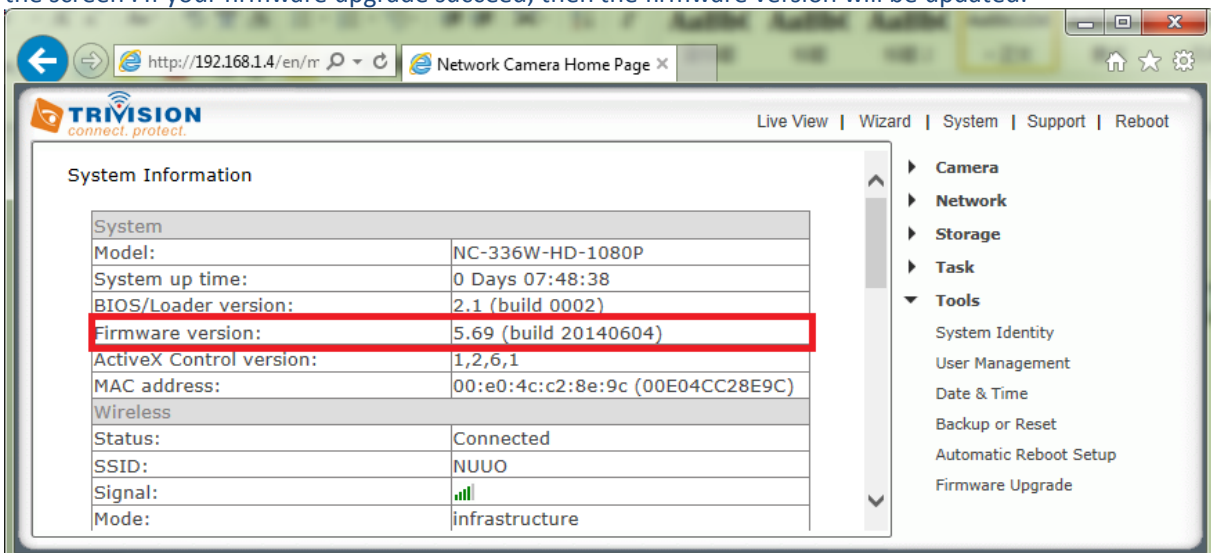



## 6.9.7 Resetting the Camera back to Factory Settings

**Note: Do not turn off the power during the Restore function since this might corrupt the camera's firmware.**

If you ever forget your admin password or have any other reason to reset the camera to its factory settings, please use the following procedure:

1. Make sure the camera is powered up
2. For indoor cameras insert the tip of a paper clip in the hole at the side of the camera to press the reset switch. You'll feel the click when the switch engages. For outdoor cameras it is easier to use the software reset function in the "Backup or Reset" menu. If hardware reset is needed, Unscrew the entire front part of the camera. It is easiest to do it if you take the sunshield off first. The reset button is right under the Micro SD card slot
3. Hold the switch down for at least 5 seconds, then let go. You'll see the power light go off for a few seconds. This indicates reset is in progress.

A few seconds later the camera will restart and is now at factory settings. Of course, after reset the user name and password will both be "admin" again (Without quotes). And you may need to set current time zone as shown below.

### Setting the time and Time Zone

After a full reset you may want to make sure the correct time and time is set. This can be done automatically if the camera has internet access and the setting is enabled as shown below:

**System time setting**

Current device time:  Time zone: GMT

Proposed device time:

Select to change the time zone for the device location:

Daylight saving time

Date and time format:  yy/mm/dd hh:mm:ss  
 mm/dd/yy hh:mm:ss  
 dd/mm/yy hh:mm:ss

Auto time setting (SNTP)  Enable  Disable

Time server   
e.g. time.nist.gov;ns.arc.nasa.gov



## Appendix A: Wireless setup instructions without Cat5

We have received inquiry from customers with no available wired network jack to plug the camera into for the initial configuration. For instance, if an Airport Express is used as the only router for a network, the signal network jack is taken by the required connection to the cable or DSL modem.

While we don't recommend this, it is still possible to configure the camera without an initial wired connection using the following procedure:

1. Temporarily rename your Wi-Fi network name (SSID) to: **wirelessnc**, and turn off all wireless security, i.e. no passwords and no MAC filtering. It is important to have the SSID all lower case and without extra spaces. Then connect to this Wi-Fi network with your laptop.
2. If you are using an Apple airport Express, use the Airport utility as shown on page 6 to reserve a fixed IP address for your camera using the camera's MAC address shown on the back of the camera.
3. Power up the camera and wait about 1 minute...the camera should connect to your Wi-Fi and you should be able to access it using the IP address that you reserved for it. If you have a Wi-Fi router or access point other than the Airport Express, you can connect to your router and look in the DHCP clients list to see the IP address of the camera if it hasn't automatically announced itself with a UPnP popup window.
4. Now go to the camera's wireless setup menu, but don't use the "Search" function. Type in the exact SSID that you had before the change in step 1, and type the exact password that you wish to use. After you hit "Apply", you won't be able to do further changes until the next step.
5. Now set your Wi-Fi SSID back to the exact same spelling as you entered into the camera's SSID field, and make sure the password and security mode are also exactly the same. Then update and restart your Wi-Fi network. You can now proceed with the setup of the camera as you should be able to see it at the same IP address as in step 3.

## Appendix B: Setup instructions for ATT (2Wire) Router

On the ATT/2Wire 2701HG and similar routers we found the UPnP does not work. For access from the internet you need to log in to the router. ATT usually has the IP address of the router configured to <http://192.168.1.254>, and the password is usually on a sticker on the bottom of the router. Go to the firewall menu, which has section for "Hosted Applications" as shown below:

First click on the blue underlined link at the bottom "Add a new user defined application". That's 2Wire's terminology for port forwarding. two applications need to be defined:

The first "application" should be named Cam1HTTP. The public TCP port range is 8150 to 8150 and the "map to host port" is 80. All other settings should be unchanged.

The second application should be named Cam1RTP. The public UDP port range is 30000-30001 and the "map to host port" is 30000.

After these 2 applications are defined, you select the camera model in the drop down box titled "Choose the computer..." and add these 2 applications so they are active for your camera. Then you save the settings and restart your router.

For the next camera, you call the first application Cam2HTTP and use public TCP port 8151 while still using "map to host" port 80. The second application would be Cam2RTP with UDP ports 30002-30003 and map-to-host port 30002.

## Appendix C: Manually entering TCP/IP Settings for a Camera

In most cases, this is not required as the router will assign the correct settings to the camera. It is however useful if you want to setup the TCP/IP settings of the camera before you connect to it, if DHCP is disabled across your network, or if you have subnet network problems.

### Assigning an IP address to the Camera with Camera Setup utility

1. Launch Camera Setup to detect the camera on your local network.
2. Select a camera, click on “Setup” and the following setup interface will pop up. Enter the default setting as below:

User name : admin; Password: admin

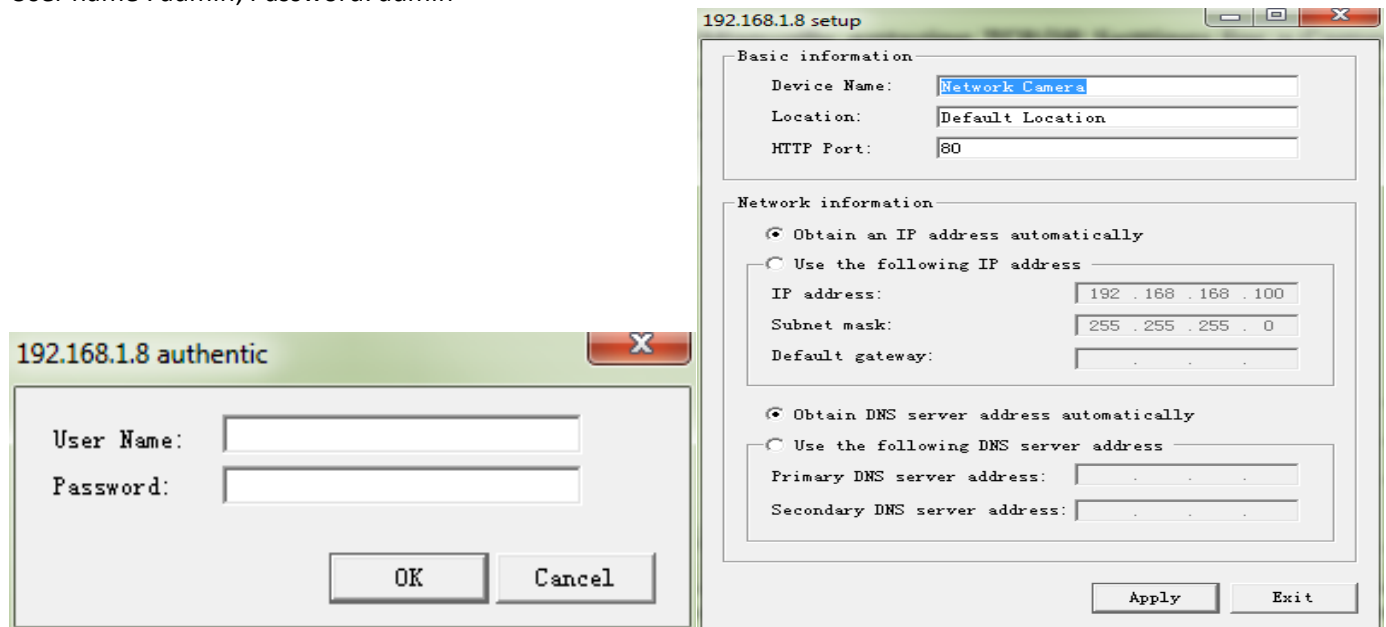

1. Enter a unique name for the camera, the location (optional) and leave the default port number as 80. “Obtain an IP address automatically” and “Obtain DNS server address automatically” are selected by default, if you are confident enough to enter your own settings, you can do so by selecting “Use the following IP address” and follow the guidelines on the next page.
2. To obtain the IP addresses specific to your network, click “Start” then “Run” and type “cmd” in the text box and click “Ok”. This will bring up the MS-DOS prompt. In this window type “ipconfig/all” and press enter. A screen similar to the one below will be displayed.
3. Take note of the following:
  - a. IP Address
  - b. Subnet Mask
  - c. Default Gateway
  - d. DNS Servers (Both numbers with the first being the primary DNS server and the second being the secondary DNS server)
4. Enter the details noted in step 6 into the relevant fields in the setup.

**Note:** The default IP address of the camera is 192.168.168.100. This can be changed to any IP address on your IP range. For example if the IP address of your PC is 192.168.1.52 then the IP address of your camera should be unique and on the same subnet, i.e. 192.168.1.X where X is any number between 1 and 255 except 52. Ensure the IP address you chose is not the same as other devices on your network as this will result in conflict and may cause the device to not work properly.

6. Once you’ve entered the details click “Apply” then “Exit”

## Appendix D: Enabling Active X in Internet Explorer

Your browser must have Active X enabled to view the camera in Internet Explorer. To activate this, do the following:

- 1) Open a new Internet Explorer window.
- 2) From the menu bar, select **Tools**, and then select **Internet options...**
- 3) From the Internet Options window, select the **Security** tab.
- 4) Click on the **Custom Level...** button.
- 5) Scroll down to the section labelled **ActiveX controls and plug-ins**. Select the option button so that they match the window below and then click **OK** to exit the window.

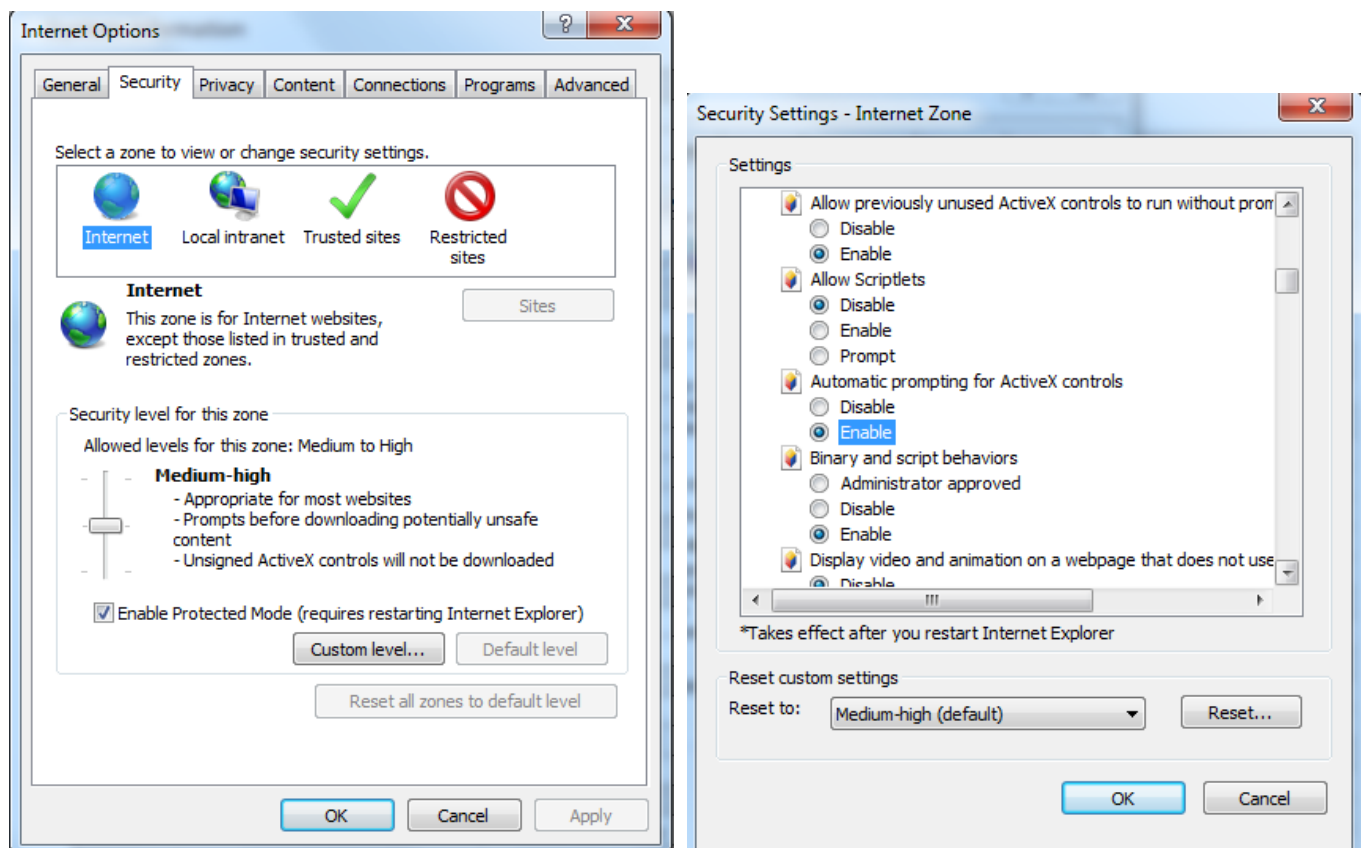

## Appendix E: Recovering from a failed Firmware update using Windows

If you have tried to install a new firmware on your camera, and the procedure has failed, your camera may be unresponsive. If the firmware update failed, and your camera's BIOS loader has become corrupted, your camera's LED will be flashing green when turned on.

There is a procedure you can try yourself, however it is quite advanced, so should only be attempted by those with a solid understanding of TCP/IP and running commands from the DOS command prompt.

### Procedure:

1. Download the correct new firmware for your camera from our technical support and save this to your hard disk.
2. Unzip (uncompress) the firmware to a directory on your PC. Copy the firmware .MFW file to an easy to access place, such as C:\firmware.
3. Write down the full name of the firmware .MFW filename.
4. Connect the camera via the Crossover Cable directly to your computer.
5. Open Network Settings on your PC, and make a note of your current TCP/IP Settings.
6. Now change your PC Network Setting to the following:  
IP Address: 192.168.168.50 Subnet Mask: 255.255.255.0  
Default Gateway: 192.168.168.1
7. Click OK to save these settings.
8. Open an MS-DOS Command Prompt, or choose "Run" from the start menu and type "cmd.exe".
9. Change the path in the command prompt to the location of the camera firmware (as in step 2) e.g. C:\firmware and then leave this window open.
10. Power off the camera, wait 5 seconds, push down on the reset button on the side of the camera, and with the reset button still pressed down, power on the camera again.
11. Release the reset button. The Green LED should start flashing indicating that the camera is in the Firmware Dump Mode.
12. Go back to your Command Prompt window on your PC.
13. Type this command in to the prompt: "tftp -i 192.168.168.1 put YOUR\_FIRMWARE\_NAME.mfw"
14. You will need to replace YOUR\_FIRMWARE\_NAME.mfw with the name of the firmware you downloaded (step 3) Press **Enter** after typing the command.
15. The camera's green LED will stop flashing. This means the firmware is being loaded.
16. **Please wait until the LED starts flashing again** – this means the firmware has finished installing.
17. Turn the power off to the camera.
18. Unplug the crossover cable.
19. Restore your TCP/IP Settings to their previous state (as in step 5)

Your camera should now be restored to its factory default settings and be working again – you can proceed to the start of the manual and setup your camera as normal.

## Appendix F: Connecting your Camera directly to a Computer

You can also connect the camera directly to a computer. **Please note that in this mode you will not be able to view your camera from anywhere else apart from the computer you are currently using.**

1. Connect one end of the network cable in to the Camera Network Connection socket, and plug the other end in to a spare network port on your computer.
  2. Connect the included power adapter to the power port on the camera and the other end into an electrical socket. Do not turn the power on at this time.
- You must then assign your computer an IP address so it can talk easily to the camera.

### On a PC:

1. Open the Control Panel and double click on “Network Connections” then right click on your “Local Area Network” connection, and click Properties. Be sure to select the Network icon that corresponds to where you have plugged the camera in to – so this **would not** be listed as a Wireless, Wi-Fi or Bluetooth Network.
  2. Select “Internet Protocol (TCP/IP)” then click Properties.
  3. Take note of your current TCP/IP Settings and then click on “Use the following IP settings”
  4. In the “IP Address” Field type in the number **192.168.168.20**
  5. In the “Subnet Mask” type in **255.255.255.0**
  6. In the “Default Gateway” type **192.168.168.1 or leave it blank**(The camera will automatically assign itself this IP address when no DHCP server is present)
  7. Leave DNS server settings blank.
  8. Click “OK” then “Close” to apply these settings.
  9. Turn the power on to the camera.
  10. The Connectivity Status indicator on the front of the camera will light up.
- You can now proceed to the Software Installation section.

### On a Mac:

1. Open “System Preferences” from the dock, and then select “Network” to edit your network settings. As the Y-cam is connected to your Mac using a cable we must choose the “Built-in-Ethernet” option. Select “Built-in Ethernet” and click the “Configure” button. Make a note of your current TCP/IP Settings.
2. Select “Manually” from the IPv4 drop-down box at the top of the dialog, and then enter these settings:  
IP Address: **192.168.168.20**  
Subnet Mask: **255.255.255.0**  
Router/Default Gateway: **192.168.168.1 or leave it blank**  
DNS Servers: Leave blank, not important at this stage.  
Search domains: Optional, leave blank, not important.
3. The click “Apply Now”.
4. Turn the power on to the camera.
5. The Connectivity Status indicator on the front of the camera will light up.

You can now proceed to the Software Installation section.

## Appendix G: Burglar Alarm system integration with digital I/O

The outdoor cameras have additional connectors to help with integration of the cameras into a complete burglar alarm system.

Typically this type of wiring is carried out by a professional security system installer. If you are not familiar with the terminology used here, please do not attempt to connect anything to this terminal block. Damage caused by improper wiring is not covered by warranty.

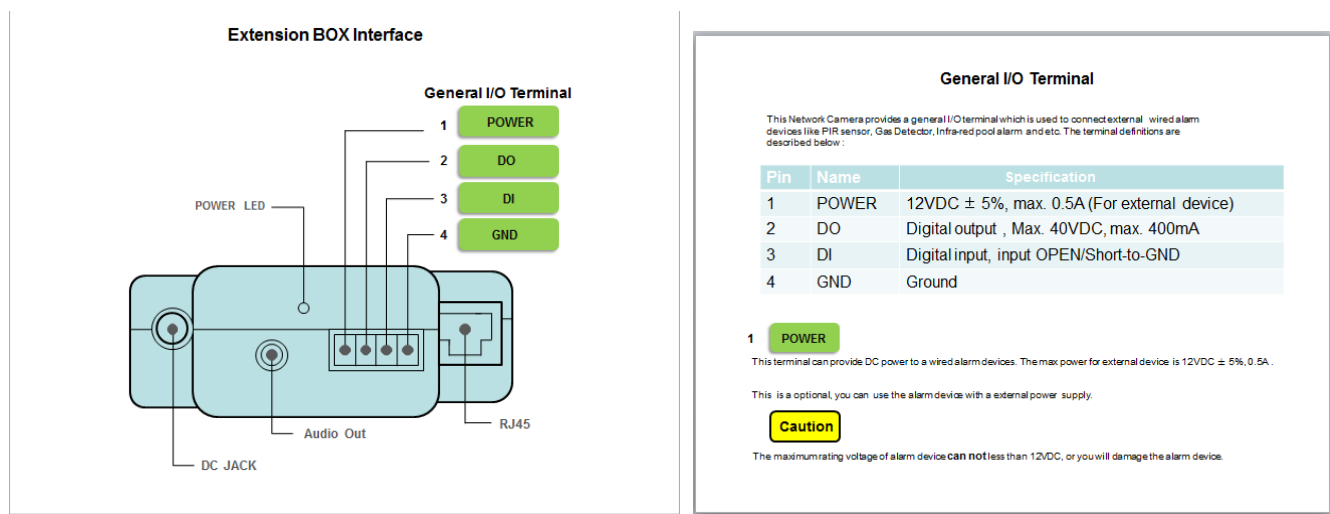

When the camera senses motion, and if the digital output is set to “Enable” in the camera’s “Digital I/O Setup” menu, it activates the digital output to trigger a burglar system. With a Maximum voltage of 60V, this output has an open collector NPN Darlington transistor with the emitter connected to the GND pin. If used with an external relay a reverse polarity diode must be connected in parallel with the relay coil to protect against voltage transients. You would need to select a relay that uses less than 0.4A at 12V, and the relay and the diode would connect pins 3 and 4.

Conversely, if the digital input is set to “Enable” in the camera’s “Digital I/O Setup” menu, a contact closure from DI to GND (pins 1 and 2) would trigger an alarm condition in the camera as if the camera’s own motion detection had triggered. This means that emails or FTP/HTTP uploads can be triggered or recording to Micro SD card can be initiated. Both the digital input and the camera’s motion detection can be active at the same tie. If you only want this external input to trigger the camera’s alarms you need to set all 4 motion detection windows in the “Motion detection” menu to disable (unchecked)

The round connector at the end of the wiring harness that looks similar to the power plug is for optional attachment of an amplified speaker system. This output is at line level similar to a computer speaker system. Using this, audio upload can be initiated from the Microphone of a computer running Internet Explorer. There is no echo suppression, so if this is used it would make sense to turn down the camera’s own microphone.

## 7.0 TROUBLESHOOTING

Problem	Cause and Remedy
I forgot the IP address of the camera	1. Use the camera Setup program.
I forgot my password to access the Settings menu	1. You will need to press the RESET button. Note: all configuration settings will be lost.
Wi-Fi connectivity doesn't work.	1. Signal strength is weak. Relocate the camera nearer to your router or remove the obstacles between the two. 2. Make sure your wireless network SSID and Encryption settings are identical to your networks. 3. Check for any interference from other equipment.
The picture viewing interface does not appear.	1. Check that your Internet Explorer settings allow you to download and install ActiveX controls. 2. Maximum 16 users are allowed to access the camera simultaneously through the network. 3. Network traffic may prevent the viewing interface from appearing quickly. Wait for a while. 4. Refresh the page.
The color of the picture is strange.	1. Confirm the colour setting of PC is 16 bits or more. 2. Identify which camera's model you have, Infrared versions of the camera sometimes have shades of color spectrum alter the images the camera displays due to the Infrared LEDs.
Unreadable characters are displayed.	1. Set the Encoding or the Character Set of the selected language on the web browser
I cannot see the controls of the Live Feed as the pictures goes over them	1. Reset your browsers Zoom setting or text size setting – pressing Ctrl and “0” (zero) at the same time should do this. 2. Try to find settings that reset your page zoom or text zoom.
The motion detection feature does not send e-mail alerts.	1. Check the e-mail alert feature is properly configured 2. The SMTP server that the IP camera uses to send the e-mail may be filtering e-mail to prevent spam from being sent from your server. Try using a different SMTP server or contact your ISP to see if SMTP access is being blocked. 3. Your Primary DNS IP Address may not be set
The power LED is flashing green and the camera is inaccessible	1. A firmware upgrade has been interrupted or the firmware has otherwise been damaged. Please contact your place of purchase or TriVision Technical Support
Motion Detection triggers unexpectedly	1. Motion detection is based on changes in pixel in the image. This means that if there are sudden changes in the lighting, motion detection may be triggered mistakenly. Lower the sensitivity setting to avoid problems.
What do the changes to the LED light mean?	Amber - Steady for connection to a 10/100 M bit/s network. Amber - Flashes for network activity. Green - Steady for connection to a wireless network. Green - Flashes for network activity.



---

## Contact US

If you encounter any problems, do not return product to the store

If you have purchased this product from an authorized retailer worldwide, you are eligible for priority email based technical support.

We are always glad to help, however we ask that you read this short manual first.

If you still have questions send us an email:

**For Technical questions, please email: [info@trivisiontech.com](mailto:info@trivisiontech.com)**

**For updated Firmware/User Manual, login our site: <http://www.trivisiontech.com>**

Most issues can be resolved very quickly. Even complicated issues are no problem for us. If you are totally stuck, we can make appointments for one-on-one telephone tech support tutorial until your camera is up and running.

Please keep in mind that remote access to your camera may require a few settings changes in your router, and that we cannot help you if you do not have your password for your own router. Also keep in mind that many routers (especially Linksys and Dlink) have many versions of the firmware, and routers with older versions of the firmware probably need to be updated.

Frequently this takes care of the most mysterious issues. Typically we do not schedule telephone tech support until your router firmware is at the latest version that is available from your router manufacturer's tech support web site. Please note that we cannot upgrade your router firmware. Please ask your router manufacturer for help with router firmware upgrades if needed.

**We pledge that we will not let you fail. Contact us with any questions, no matter how simple or how complicated.**